



# KOPEK INTERNATIONAL



Chirurgie - Surgery - Cirugia - Chirurgie - Chirurgia

Skalpellklingen, steril, Skalpellgriffe  
 Scalpel Blades, Sterile, Scalpel Handles  
 Lames de bistouris, stériles, Manches de bistouris  
 Hojas de bisturios estériles, Mangos de bisturios  
 Lame da bisturi, sterili, Manici per bisturi

In Packungen zu 100  
 in packages of 100 ea  
 en boîtes de 100 pieces  
 en cajas de 100 c/u  
 in scatole di 100 pezzi

**CARBON STEEL**

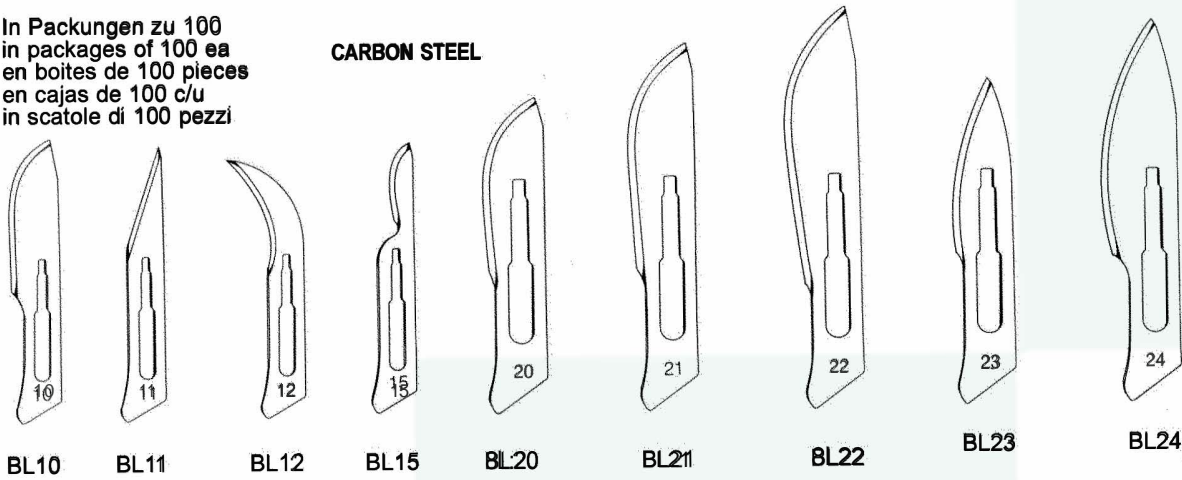

08.151  
Fig. 3L

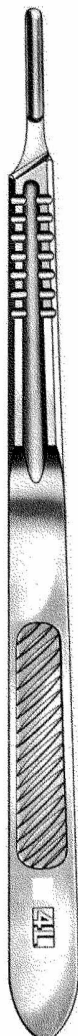

08.152  
Fig. 4L

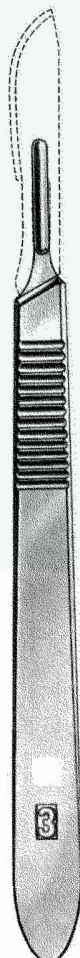

08.161  
Fig. 3

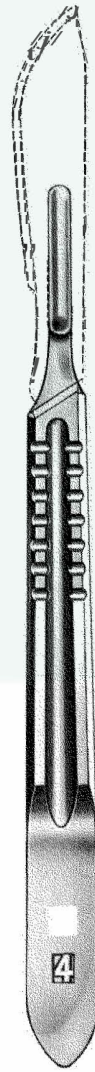

008.162  
Fig. 4



08.125

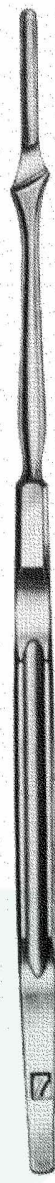

08.126



08.129  
#11



08.130  
#2

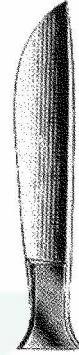

08.131  
#3



08.132  
#4



08.133  
#5



08.134  
#113

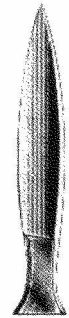

08.135  
#114



08.136  
#115

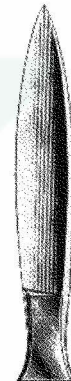

08.137  
#116

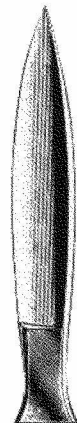

08.138  
#17

1

2

3

4

5

6

7

8

9

10

11

12

13

14

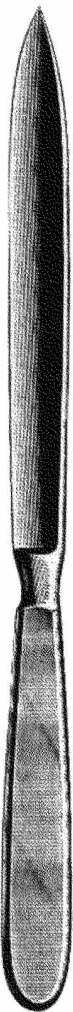

**AMPUTATING**  
 08.139 13cm  
 08.140 16cm  
 08.141 19cm  
 08.142 22cm  
 08.143 28cm



**LISTON**  
 08.144 17cm  
 08.145 20cm



**CATLIN**  
 08.146 16cm  
 08.147 19cm  
 08.148 22cm



**LANGENBECK**  
 08.149 12 cm



**LANGENBECK**  
 08.150 10.5cm



**IRIS**  
 SUPER CUT  
 10 cm

**113 91 0685**  
 rovné hrotnaté – straight sharp

**113 91 0686**  
 zahnuté hrotnaté – curved sharp



**JABALEY**  
 SUPER CUT  
 12 cm

**113 91 0687**  
 rovné hrotnaté – straight sharp

**113 91 0688**  
 zahnuté hrotnaté – curved sharp



**STEVENS**  
 SUPER CUT  
 12,5 cm

**113 91 0689**  
 rovné hrotnaté – straight sharp

**113 91 0690**  
 zahnuté hrotnaté – curved sharp



**LISTER (BANDAGE)**  
**113 91 0691**  
 14 cm

1

2

3

4

5

6

7

8

9

10

11

12

13

14



**MAYO**  
 SUPER CUT  
 15 cm

**113 91 0692**  
 rovné – straight

**113 91 0693**  
 zahnuté – curved



**MAYO-STILLE**  
 SUPER CUT

**113 91 0694**  
 15 cm  
 rovné – straight

**113 91 0695**  
 17 cm  
 rovné – straight

**113 91 0696**  
 15 cm  
 zahnuté – curved

**113 91 0697**  
 17 cm  
 zahnuté – curved



**MAYO-HARRINGTON**  
 SUPER CUT

**113 91 0698**  
 20 cm  
 rovné – straight

**113 91 0699**  
 23 cm  
 rovné – straight



**RANGEL-STILLE**  
 SUPER CUT

**113 91 0700**  
 12,5 cm  
 zahnuté – curved

**113 91 0701**  
 15 cm  
 zahnuté – curved

**113 91 0702**  
 18 cm  
 zahnuté – curved

**113 91 0703**  
 20 cm  
 zahnuté – curved

**113 91 0704**  
 23 cm  
 zahnuté – curved



**METZENBAUM**  
 SUPER CUT

**113 91 0705**  
 15 cm  
 rovné – straight

**113 91 0706**  
 18 cm  
 rovné – straight

**113 91 0707**  
 20 cm  
 rovné – straight

**113 91 0708**  
 23 cm  
 rovné – straight

**113 91 0709**  
 26 cm  
 rovné – straight



**METZENBAUM**  
 SUPER CUT

**113 91 0710**  
 15 cm  
 zahnuté – curved

**113 91 0711**  
 18 cm  
 zahnuté – curved

**113 91 0712**  
 20 cm  
 zahnuté – curved

**113 91 0713**  
 23 cm  
 zahnuté – curved

**113 91 0714**  
 26 cm  
 zahnuté – curved



**BABY METZENBAUM**  
 SUPER CUT

**113 91 0715**  
 12,5 cm  
 rovné – straight

**113 91 0716**  
 12,5 cm  
 zahnuté – curved

1

2

3

4

5

6

7

8

9

10

11

12

13

14

Super Cut Scissors  
 Super Ciseaux Coupe  
 Super Cut Tijeras  
 Super rezu Nůžky  
 Forbici taglio eccellente



**IRIS**  
 bez tvrdokovu – without TC  
 11,5 cm

**113 91 0717**  
 rovné – straight

**113 91 0718**  
 zahnuté – curved



**IRIS**  
 s tvrdokovem – with TC  
 11,5 cm

**113 91 0719**  
 rovné – straight

**113 91 0720**  
 zahnuté – curved



**LA GRANGE**  
 bez tvrdokovu – without TC  
 11,5 cm

**113 91 0721**



**LA GRANGE**  
 s tvrdokovem – with TC  
 11,5 cm

**113 91 0722**

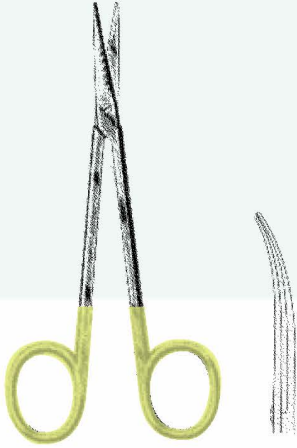

**STRABISMUS**  
 11.0974 11.5 cm str  
 11.0975 11.5 cm cvt

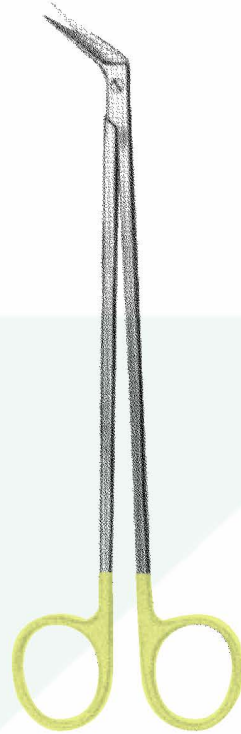

**POTTSMITH**

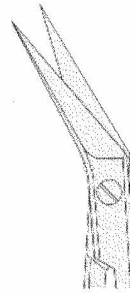

**POTTSMITH**  
 11.0987 19cm

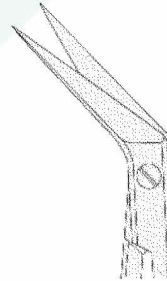

**POTTSMITH**  
 11.0988 19 cm

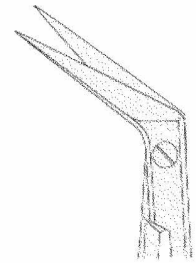

**POTTSMITH**  
 11.0989 19 cm

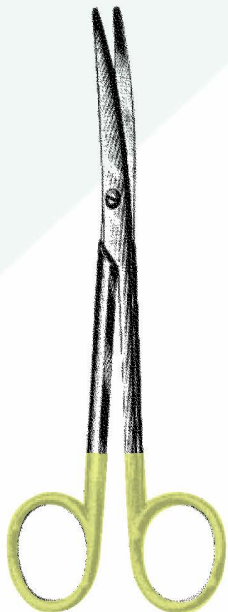

**MAYO-LEXER**  
 11.0979 16 cm



**MAYO-LEXER**  
 11.0980 16 cm

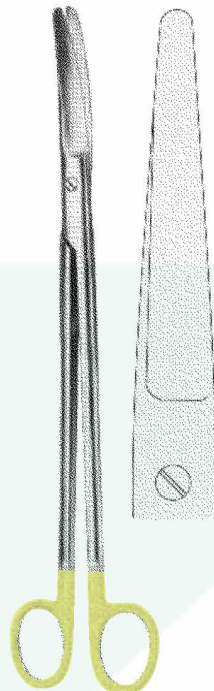

**MAYO-HARRINGTON**  
 11.0981 23 cm str  
 11.0982 28 cm str



11.0983 23 cm cvd  
 11.0984 28 cm cvd

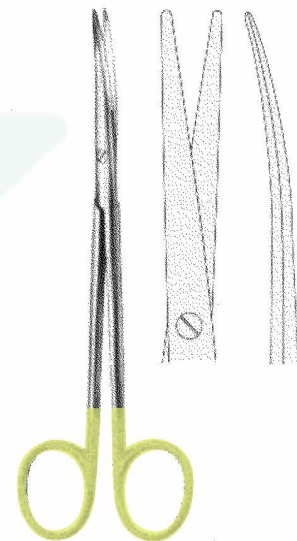

**TOENNIS-ADSON**  
 11.0985 18 cm

Scissors With Tungsten-carbide Instruments  
 Scheren Mit Hartmetalleinsätzen  
 Ciseaux A Bouts de Carbure Tungstene  
 Tijeras, Filos de Carburo de Tungsteno

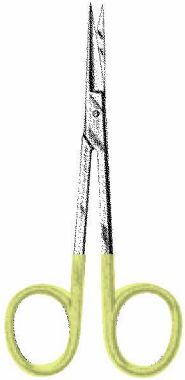

IRIS  
11.0910 11.5 cm

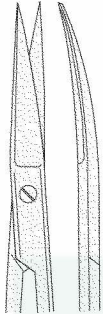

IRIS  
11.0911  
11.5 cm

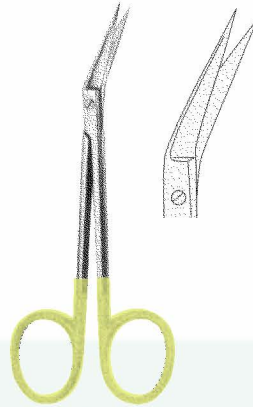

IRIS  
11.0912  
11.5 cm

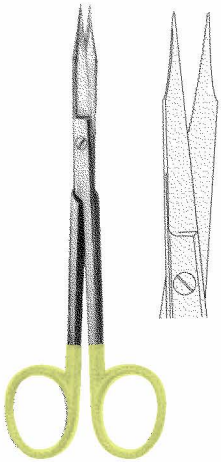

GOLDMAN-FOX  
11.0913 13 cm

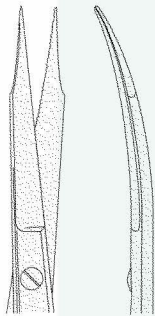

GOLDMAN-FOX  
11.0914 14 cm



BABY-LEXER  
11.0990 10 cm



BABY-LEXER  
11.0991 10 cm

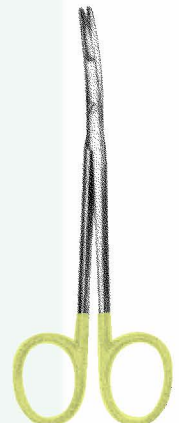

RAGNELL  
11.0992  
11.5 cm

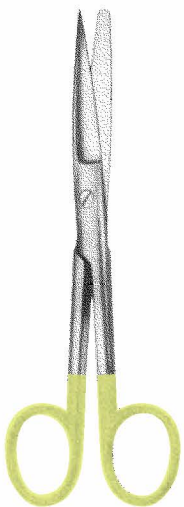

STANDERD

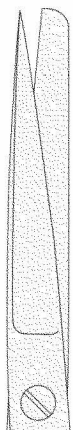

11.0993  
14.5 cm

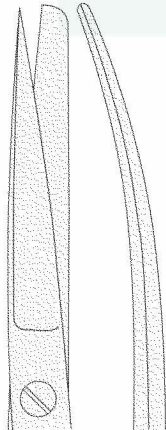

11.0994  
14.5 cm



11.0995  
14.5 cm

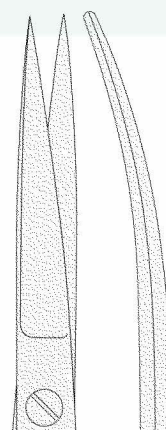

11.0996  
14.5 cm



11.0997  
14.5 cm

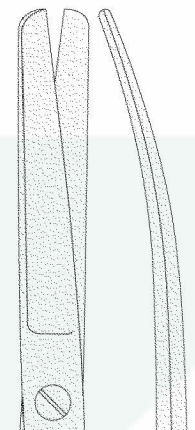

11.0998  
14.5 cm

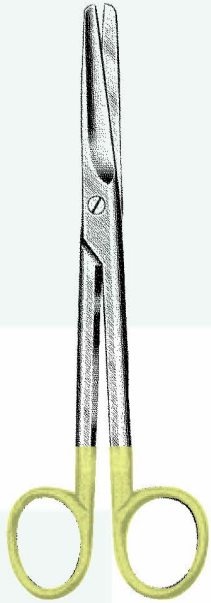

**MAYO**  
 11.0999 TC  
 14.5 cm  
 11.1000 TC  
 17 cm  
 11.1001 TC  
 23 cm

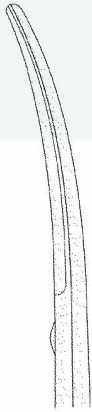

**MAYO**  
 11.1002 TC  
 14.5 cm  
 11.1003 TC  
 17 cm  
 11.1004 TC  
 23 cm

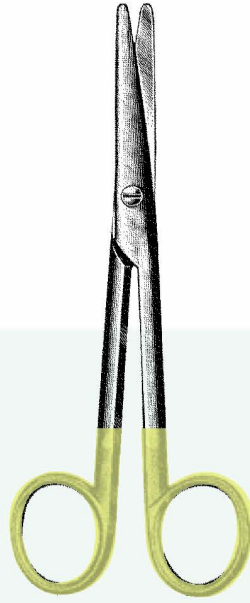

**MAYO-STILLE**  
 11.1002 TC 15 cm  
 11.1003 TC 17 cm



**MAYO-STILLE**  
 11.1004 TC 15 cm  
 11.1005 TC 17 cm

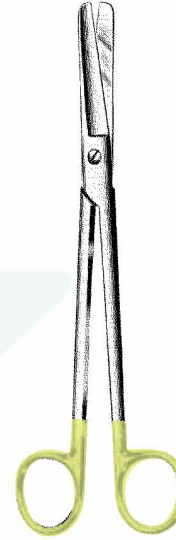

**SIMS**  
 11.1006 TC  
 23 cm

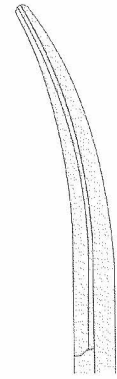

**SIMS**  
 11.1007 TC  
 23 cm

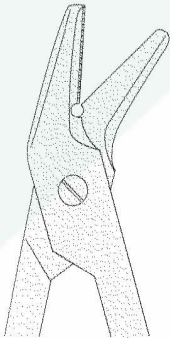

**UNIVERSAL**  
 11.1008 TC 12.5 cm

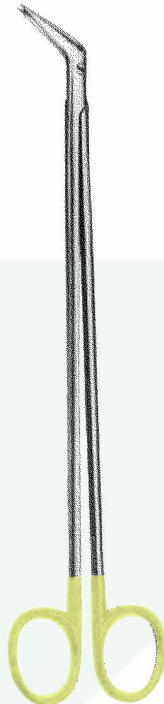

**DEBAKEY**



**DEBAKEY**  
 11.1009 TC 19 cm  
 11.1010 TC 23 cm  
 11.1011 TC 28 cm

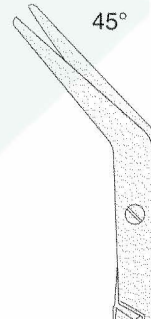

**DEBAKEY**  
 11.1012 TC 19 cm  
 11.1013 TC 23 cm  
 11.1014 TC 28 cm

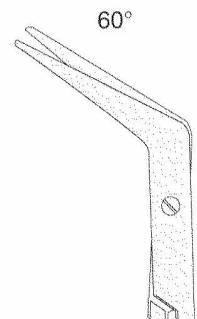

**DEBAKEY**  
 11.1015 TC 19 cm  
 11.1016 TC 23 cm  
 11.1017 TC 28 cm

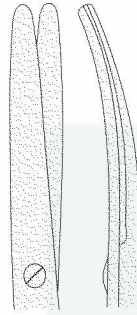

**METZENBAUM**  
 11.1018 TC 14.5 cm  
 11.1019 TC 18 cm  
 11.1020 TC 20 cm  
 11.1021 TC 23 cm  
 11.1022 TC 25 cm  
 11.1023 TC 28 cm  
 11.1024 TC 30 cm

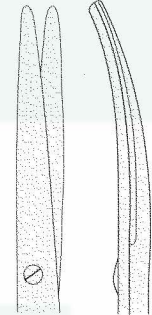
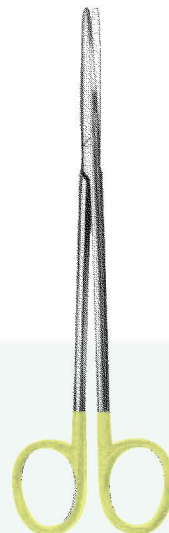

**METZENBAUM-FINO**  
 11.1032 TC 14.5 cm  
 11.1033 TC 18 cm  
 11.1034 TC 20 cm  
 11.1035 TC 23 cm  
 11.1029 TC 25 cm  
 11.1036 TC 25 cm  
 11.1037 TC 28 cm

**METZENBAUM-FINO**  
 11.1038 TC 14.5 cm  
 11.1039 TC 18 cm  
 11.1040 TC 20 cm  
 11.1041 TC 23 cm  
 11.1042 TC 25 cm  
 11.1043 TC 28 cm

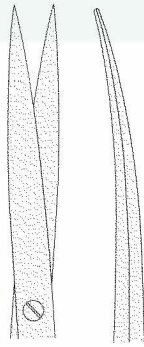
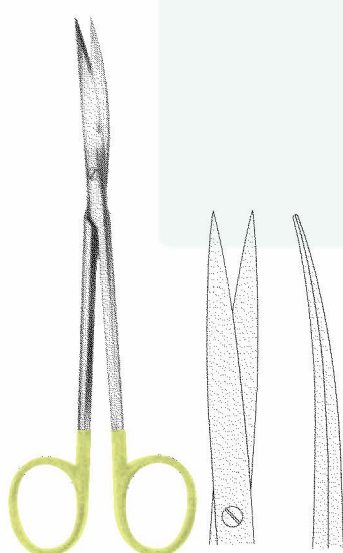
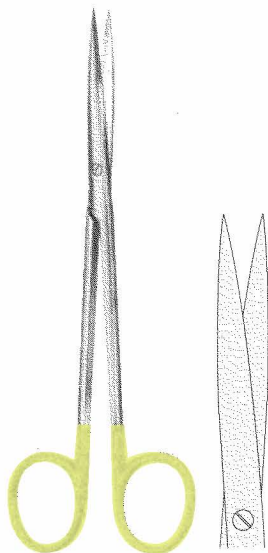

**METZENBAUM X-FINO**  
 11.1044 TC 14.5 cm  
 11.1045 TC 18 cm  
 11.1046 TC 20 cm  
 11.1047 TC 23 cm

**METZENBAUM X-FINO**  
 11.1048 TC 14.5 cm  
 11.1049 TC 18 cm  
 11.1050 TC 20 cm  
 11.1051 TC 23 cm

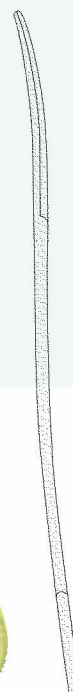
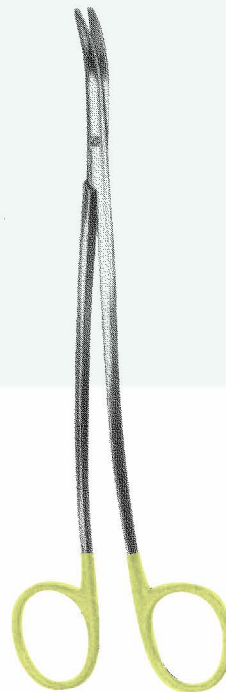

**METZENBAUM**  
 11.1052 TC 18 cm  
 11.1053 TC 20 cm  
 11.1054 TC 23 cm

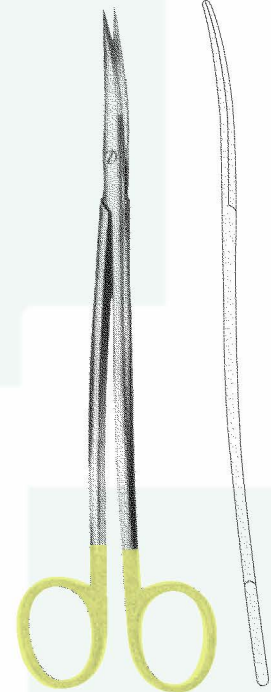

**METZENBAUM-FINO**  
 11.1055 TC 18 cm  
 11.1056 TC 20 cm  
 11.1057 TC 23 cm

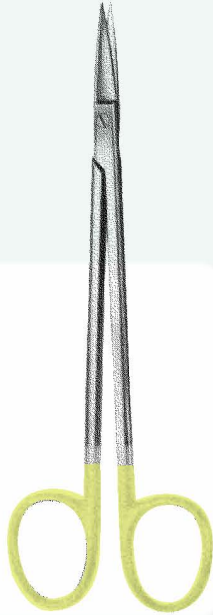

**KELLY**  
 11.1058 TC 16 cm

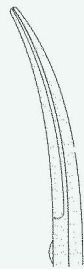

**KELLY**  
 11.1059 TC 16 cm

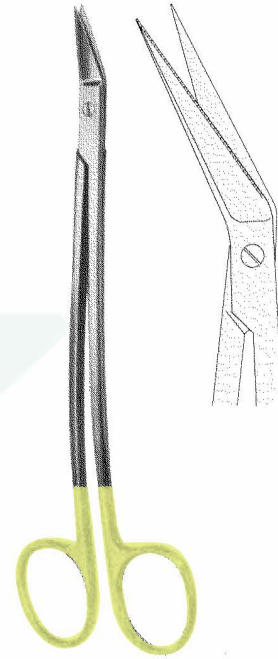

**LOCKLIN**  
 11.1060 TC 16 cm

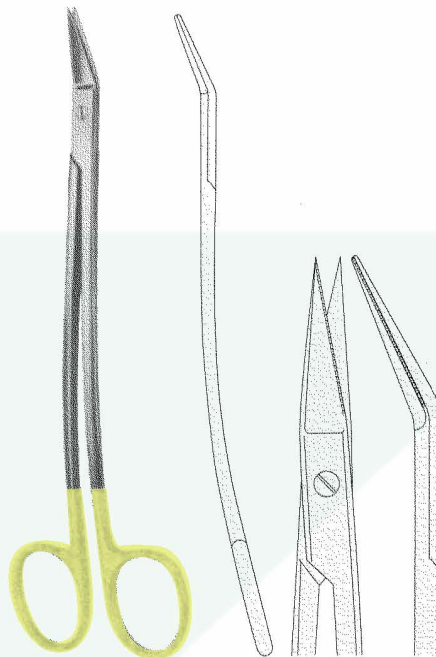

**DEAN**  
 11.1061 TC 17 cm  
 glatt / smooth  
 lisse / lisa  
 11.1062 TC 17 cm  
 gezahnt / serrated  
 dentee / dentada

1

2

3

4

5

6

7

8

9

10

11

12

13

14



**BABY-RILE**  
 11.3609 15 cm



**CRILE WOOD**

11.3610  
15 cm

11.3611  
18 cm

11.3612  
20 cm

11.3613  
23 cm

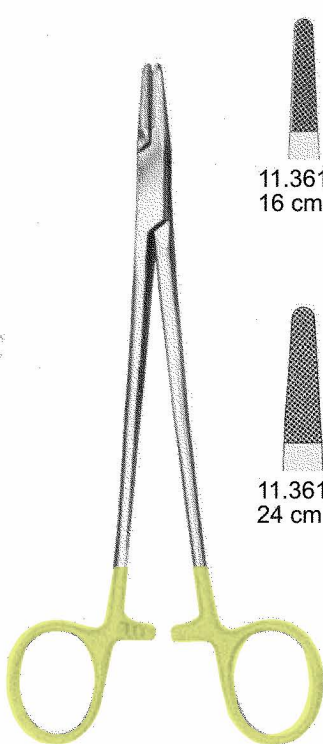

**MAYO-HEGAR**

11.3614  
16 cm

11.3615  
18 cm

11.3616  
20 cm

11.3620  
18 cm

11.3621  
20 cm

11.3622  
23 cm

11.3617  
24 cm

11.3618  
26 cm

11.3619  
30 cm

11.3623  
25 cm

11.3624  
31 cm

11.3625  
37 cm

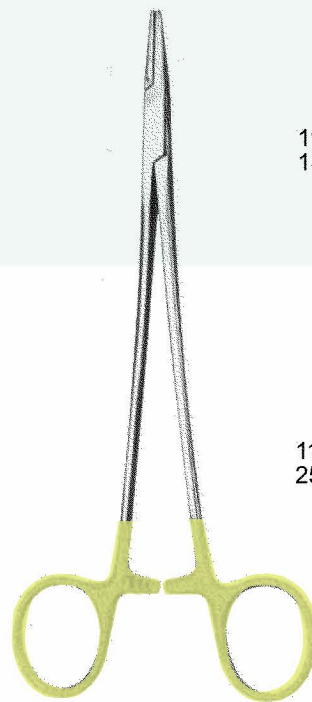

**DEBAKEY**

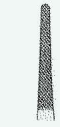

11.3627  
15 cm



11.3628  
18 cm



11.3629  
20 cm



11.3630  
23 cm

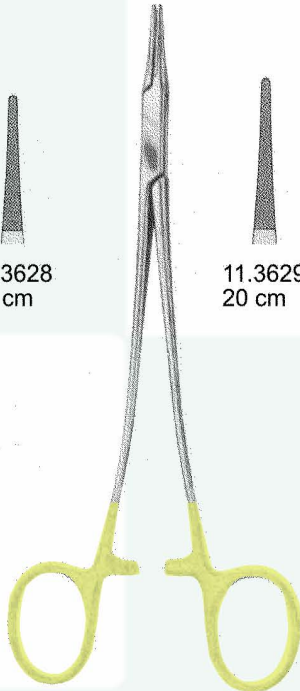

MICRO-VASCULAR



11.3639  
20 cm



11.3640  
24 cm

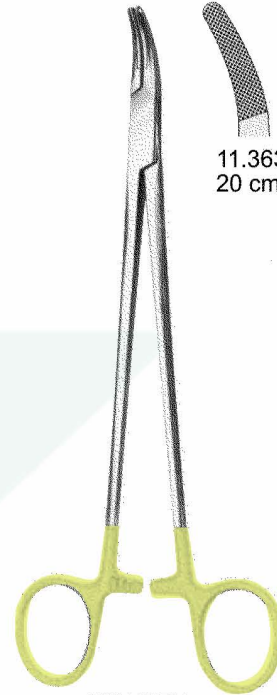

HEANEY



11.3641  
28 cm

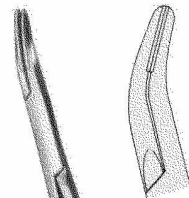

11.3642  
21 cm



11.3643  
23 cm

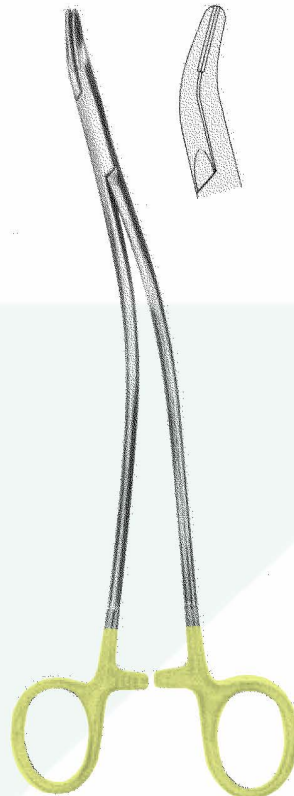

STRATTE



GILLIES-MINI  
11.3654 14 cm

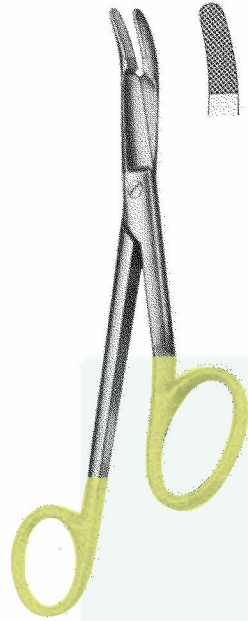

GILLIES  
11.3655 16 cm

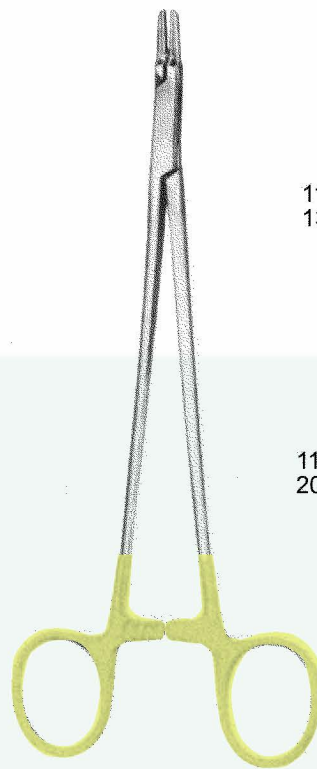

RYDER

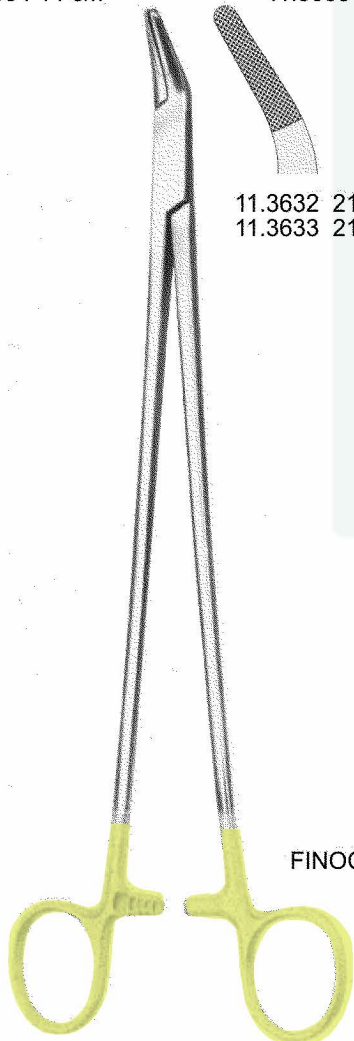
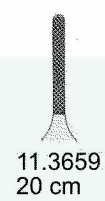
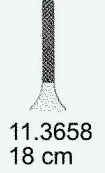
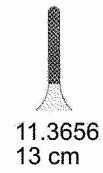

FINOCHIETTO

11.3632 21 cm  
11.3633 21 cm

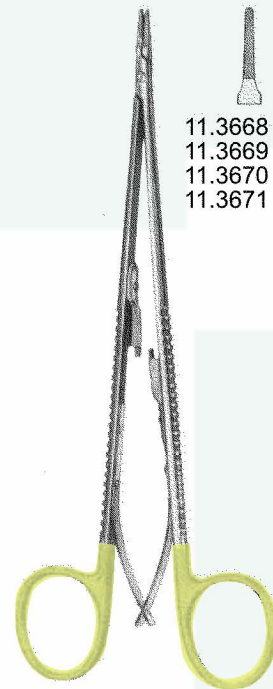

DIETRICH

11.3668 18 cm  
11.3669 20 cm  
11.3670 23 cm  
11.3671 26 cm

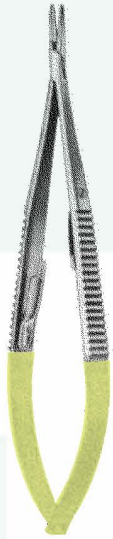

CASTROVIEJO



11.3674  
11.3675  
11.3676

14 cm  
18 cm  
21 cm



11.3677  
11.3678  
11.3679



11.3680  
11.3681  
11.3682

14 cm  
18 cm  
21 cm



11.3683  
11.3684  
11.3685

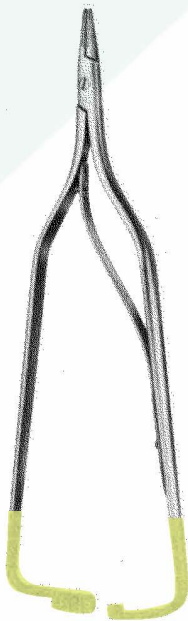

ARRUGA  
16 cm



11.3687



11.3688

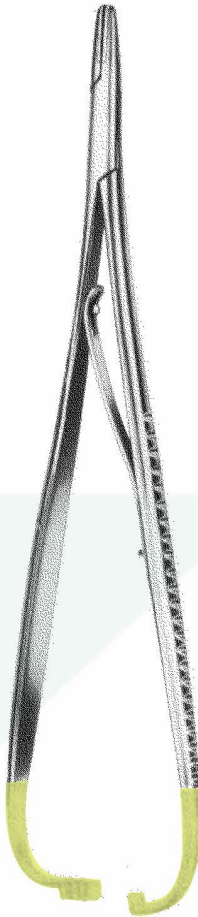

MATHIEU



11.3647  
14 cm



11.3648  
17 cm



11.3649  
20 cm



11.3650  
23 cm

Gerade  
 Straight  
 Droits  
 Rectas  
 Rette

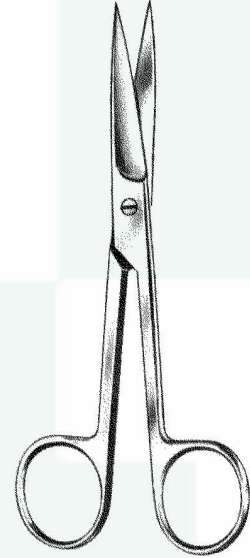
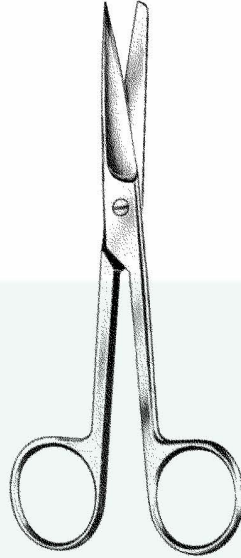
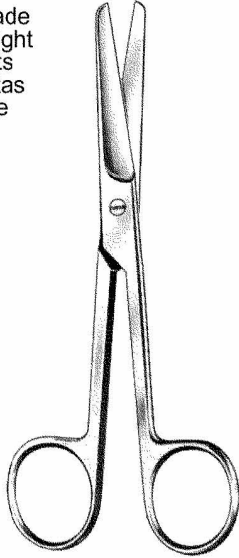

cm	Standard	Standard	Standard
10.5	11.1000	11.1020	11.1040
11.5	11.1001	11.1021	11.1041
13.0	11.1002	11.1022	11.1042
14.5	11.1003	11.1023	11.1043
15.5	11.1004	11.1024	11.1044
16.5	11.1005	11.1025	11.1045
18.5	11.1006	11.1026	11.1046
20.0	11.1007	11.1027	11.1047

Gebogen  
 Curved  
 Courbes  
 Curvas  
 Curve

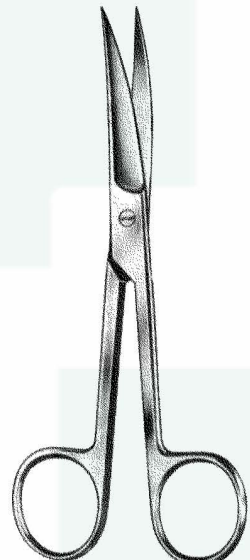
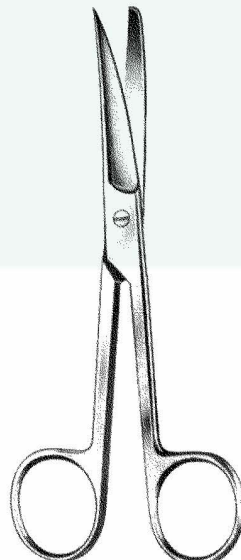
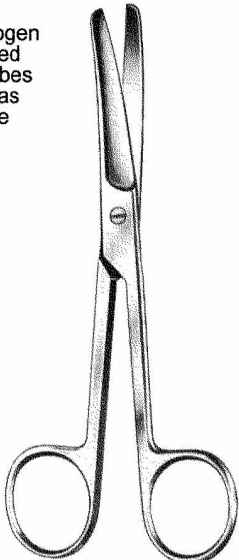

cm	Standard	Standard	Standard
11,5	11.1010	11.1030	11.1050
13,0	11.1011	11.1031	11.1051
14,5	11.1012	11.1032	11.1052
15,5	11.1013	11.1033	11.1053
16,5	11.1014	11.1034	11.1054
18,5	11.1015	11.1035	11.1055
20,0	11.1016	11.1036	11.1056

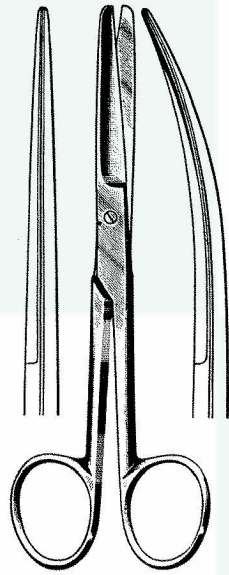

— DEAVER —  
 11.1060 14cm 11.1061

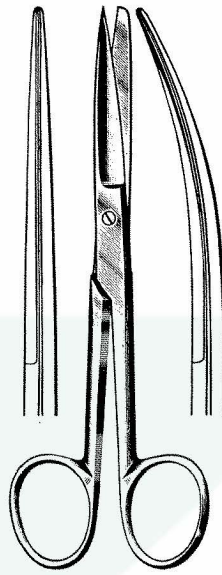

— DEAVER —  
 11.1070 14cm 11.1071

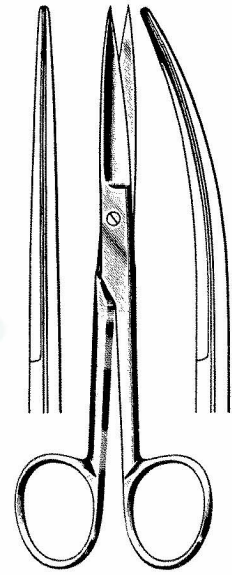

— DEAVER —  
 11.1080 14cm 11.1081

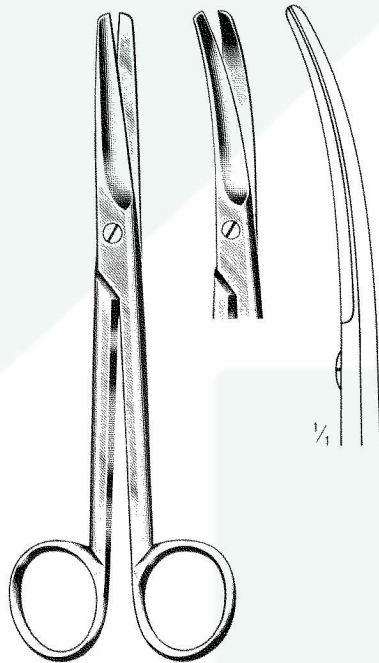

cm — MAYO —  
 14,5 11.1090 11.1093  
 17.0 11.1091 11.1094  
 23.0 11.1092 11.1095

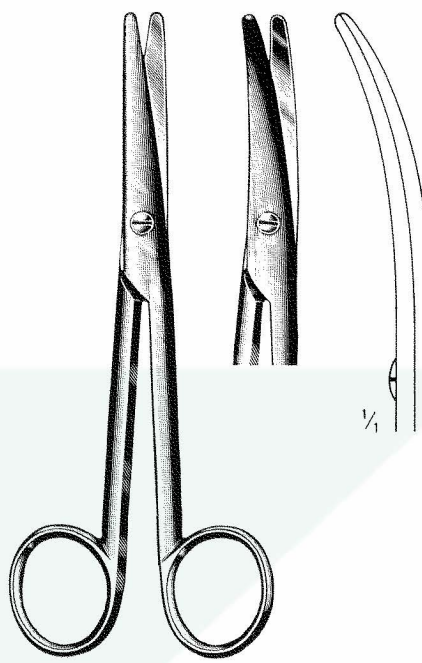

cm — MAYO-STILLE —  
 15,0 11.1100 11.1102  
 17.0 11.1101 11.1103

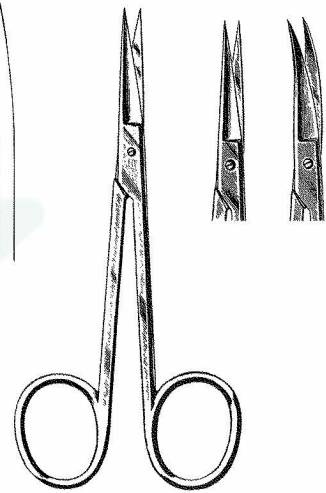

— IRIS Standard —  
 11.1110 9 cm 11.1112  
 11.1111 11 cm 11.1113

Chirurgische Scheren  
 Operating Scissors  
 Ciseaux à chirurgie  
 Tijeras para cirugía  
 Forbici per chirurgia

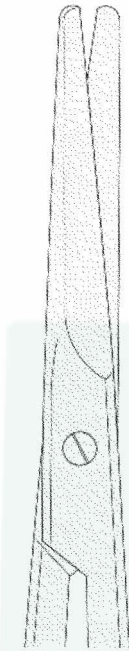
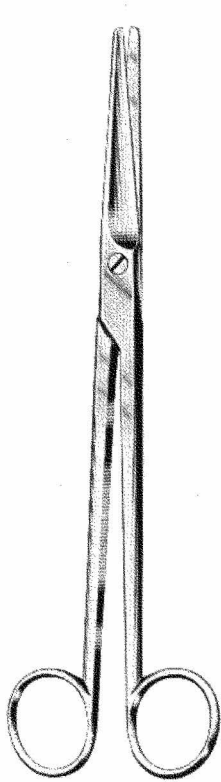

MAYO-  
 HARRINGTON  
 11.0922 23 cm

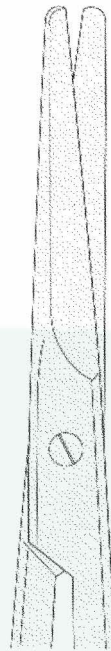

MAYO-  
 HARRINGTON  
 11.0923 23 cm  
 11.0924 30 cm

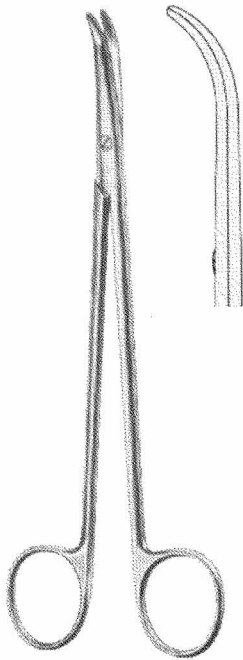

THOREK  
 11.0925 19 cm  
 11.0926 23 cm

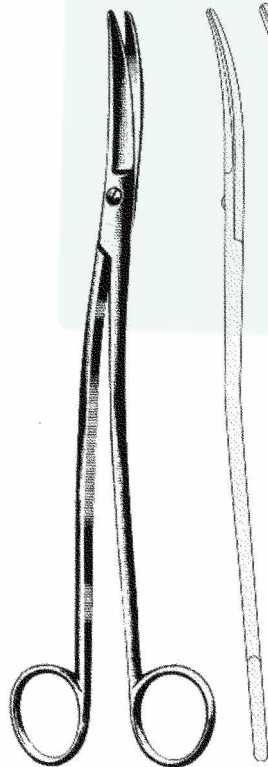

KLINGEN-  
 BERGLOTH  
 11.0927 23 cm



SATINSKY  
 11.0928 24.5 cm

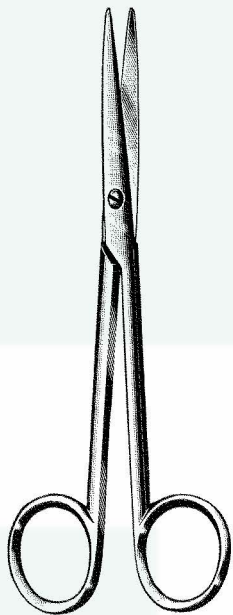

cm LEXER  
 16 11.1120  
 21 11.1121

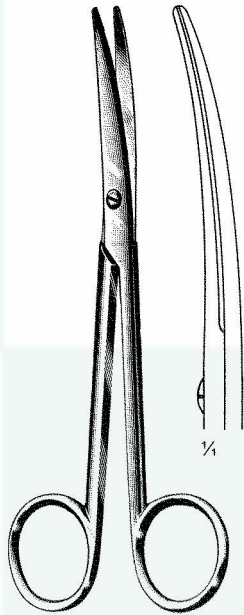

LEXER  
~~11.1122~~  
 11.1123

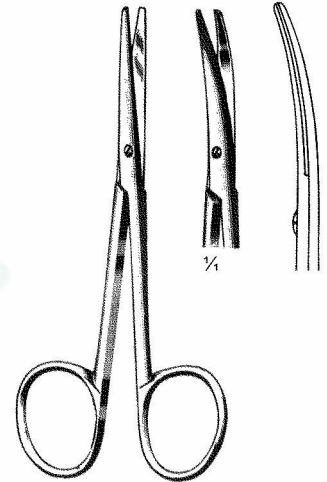

cm — LEXER BABY —  
 10 11.1124 11.1125

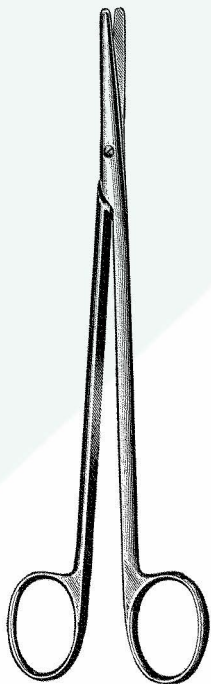

cm METZENBAUM  
 15 11.1130  
 18 11.1131  
 20 11.1132  
 23 11.1133  
 25 11.1134  
 28 11.1135  
 30 11.1136

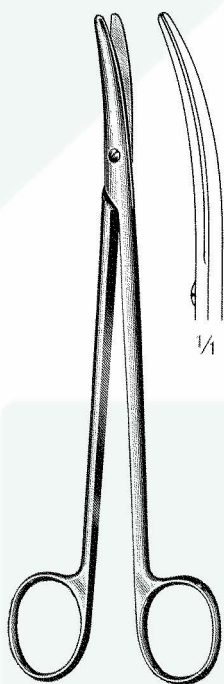

~~METZENBAUM~~  
 11.1140  
 11.1141  
 11.1142  
 11.1143  
 11.1144  
 11.1145  
 11.1146

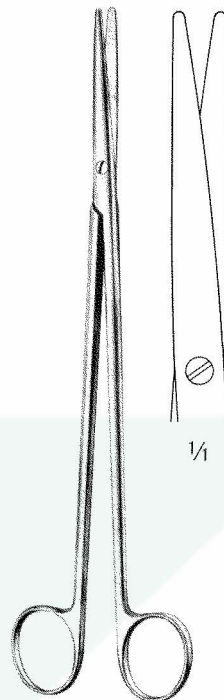

METZENBAUM FINO  
 11.1150  
 11.1151  
 11.1152  
 11.1153

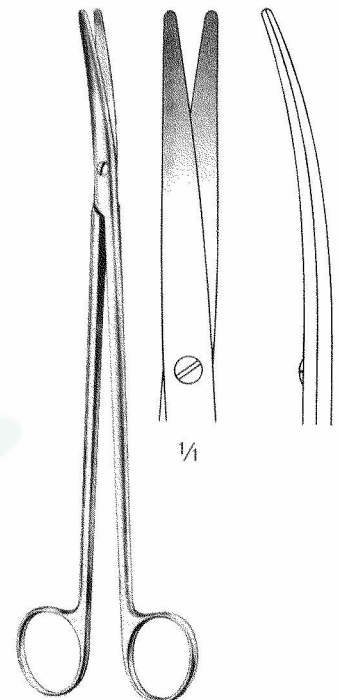

METZENBAUM FINO  
 11.1160  
 11.1161  
 11.1162  
 11.1163

Gynäkologische Scheren  
 Gynaecological Scissors  
 Ciseaux gynécologiques  
 Tijeras ginecológicas  
 Forbici ginecologiche

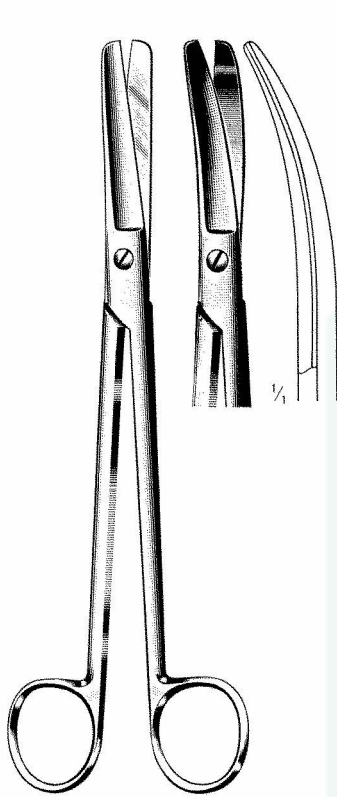

cm	SIMS	
20	11.1170	11.1172
23	11.1171	11.1173

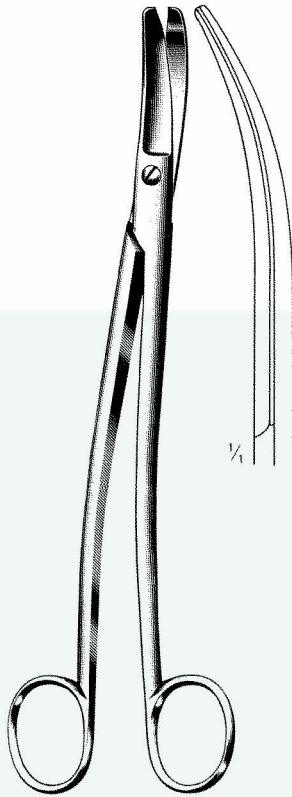

SIEBOLD		WERTHEIM
11.1180		11.1181
24 cm		22,5 cm

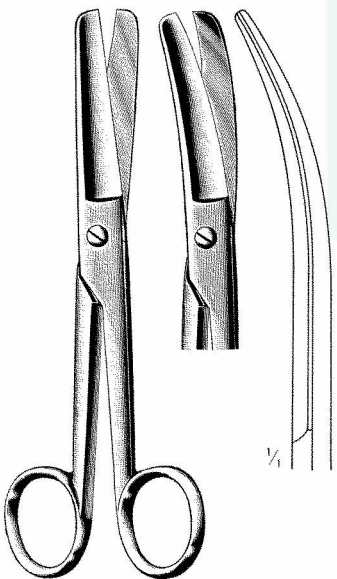
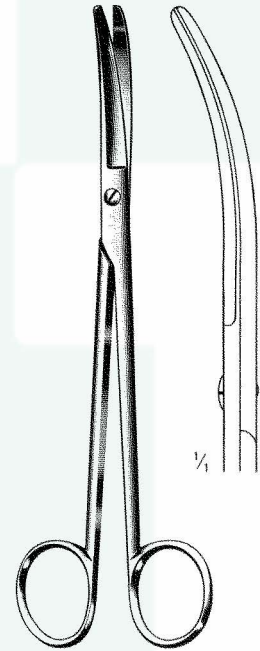

cm	DOYEN	
17.5	11.1182	11.1183

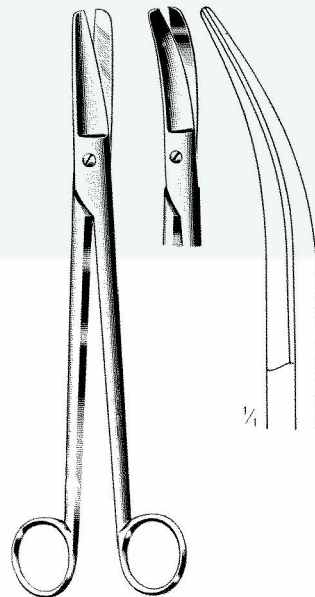

cm	DUBOIS	
27	11.1184	11.1185

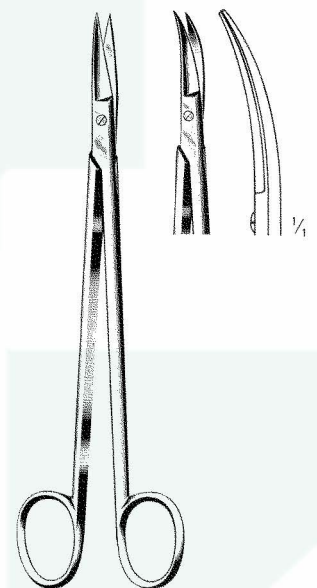

cm	KELLY	
16	11.1186	11.1188
18	11.1187	11.1189

Nabelschnur-Scheren  
 Umbilical Scissors  
 Ciseaux ombilicaux  
 Tijeras umbilicales  
 Forbici ombelicali

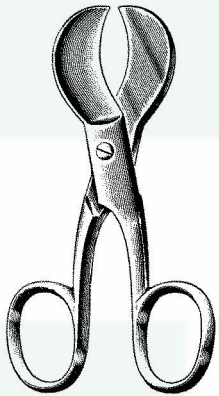

U.S.A. Mod  
 11.1190.  
 10.5 cm

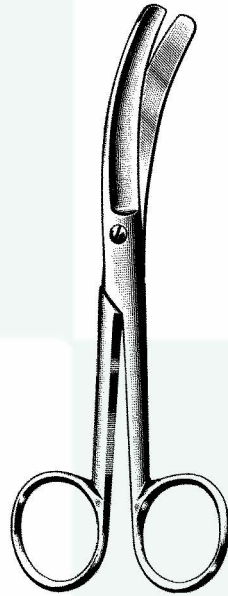

BUSCH  
 11.1191  
 16 cm



SCHUMACHER  
 11.1192  
 14 cm

Episiotomie - Episiotomy  
 Episiotomia

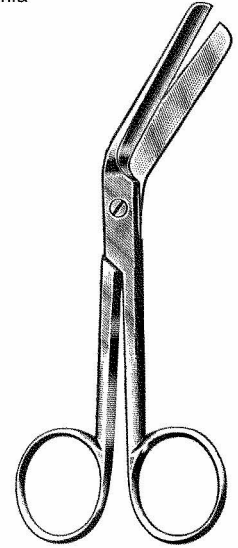

cm	BRUAN-STADLER
14,5	11.1193
22,0	11.1194

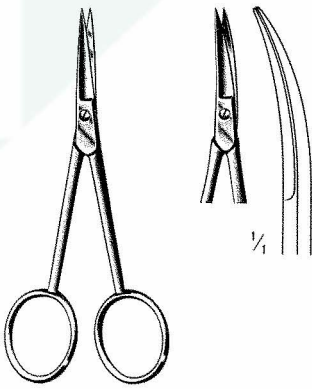

cm  
 11.1195 11 11.1196

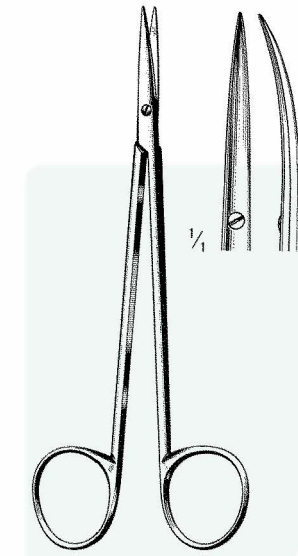

cm  
 11.1197 15 11.1198

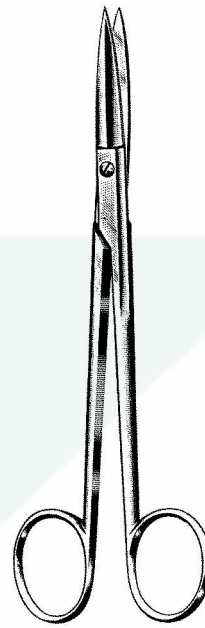

McINDOE  
 11.1199  
 19 cm

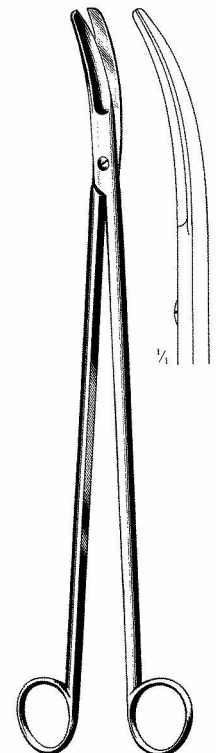

CRAFOORD  
 11.1200  
 30 cm

Chirurgische Scheren  
 Operating Scissors  
 Ciseaux à chirurgie  
 Tijeras para cirugía  
 Forbici per chirurgia



Darmscheren  
 Enterotomy Scissors  
 Ciseaux à entérotomie  
 Enterótomos  
 Forbici per enterotomia

11.1210  
21 cm

11.1211  
21 cm

11.1212  
21 cm

Ligaturscheren  
 Stitch Scissors  
 Ciseaux à ligatures  
 Tijeras para puntas  
 Forbici per legature



SPENCER (sharp)  
 11.1213  
 9 cm

SPENCER (sharp)  
 11.1214  
 11 cm

NORTHBENT (blunt)  
 11.1215  
 13 cm

LITTAUER  
 11.1216  
 14 cm

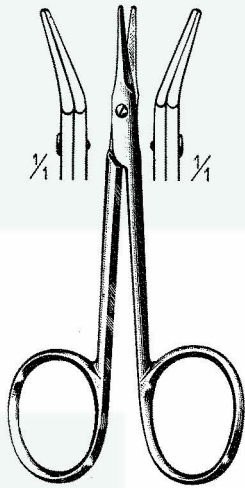

AEBLI  
 11.1220 9cm 11.1221

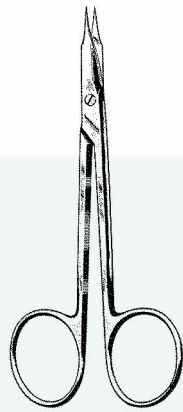

STEVENS  
 11 cm

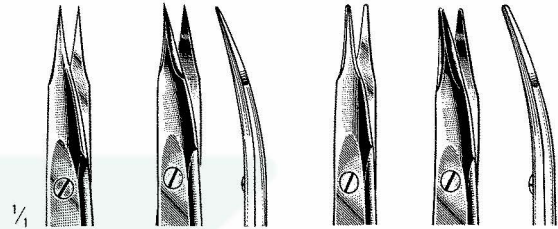

11.1222 11.1223 11.1224 11.1225

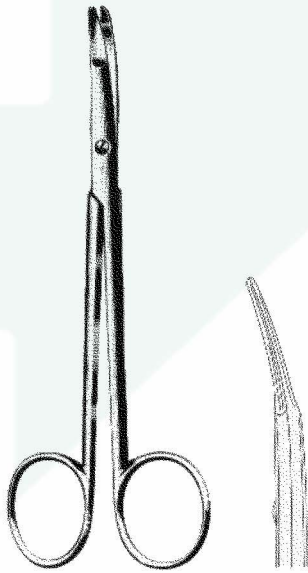

KILNER 11.0964 12 cm  
 KILNER 11.0965 12 cm  
 KILNER 11.0966 15 cm

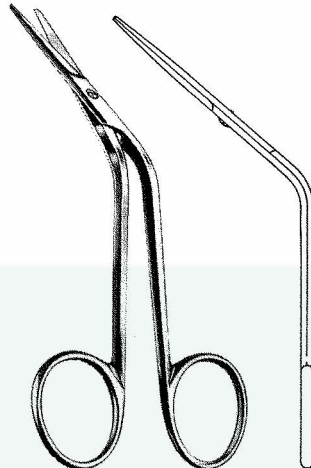

COTTLE  
 11.1226  
 16 cm

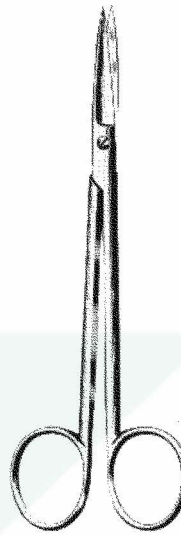

JOSEPH  
 11.0968 14 cm  
 glatt / smooth  
 lisse / lisa

11.0969 14 cm  
 gezahnt / serrated  
 dentees / dentadas



JOSEPH  
 11.0970 14 cm  
 glatt / smooth  
 lisse / lisa

11.0971 14 cm  
 gezahnt / serrated  
 dentees / dentadas

Tonsillen-, Gefäß-Scheren  
 Tonsil, Vascular Scissors  
 Ciseaux amygdal., vasculaires  
 Tijeras, amígdal., vasculares  
 Forbici, tonsill., vascolari

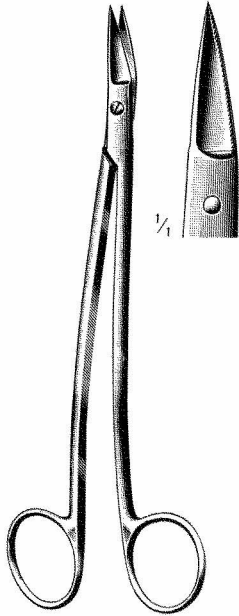

DEAN  
 11.1230 17 cm 11.1231

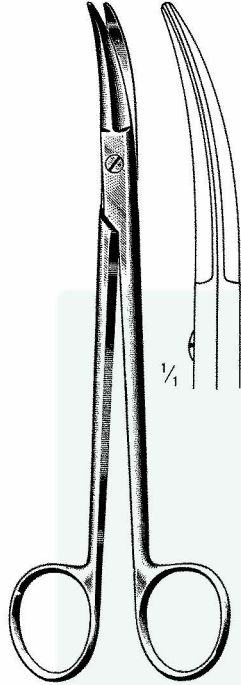

PRINCE  
 11.1232  
 17 cm

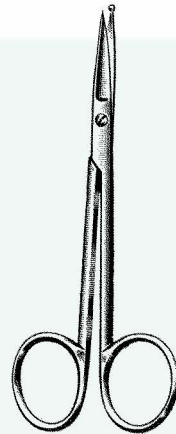

11.1233  
 11cm

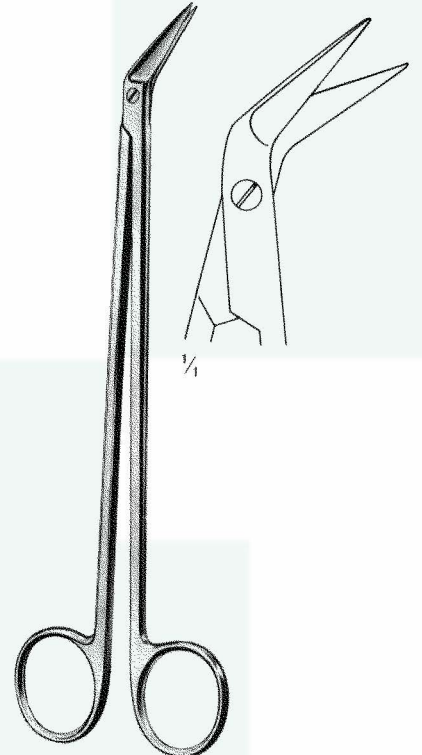

POTTS-DE MARTEL  
 cm 11.1234  
 21 11.1235  
 24

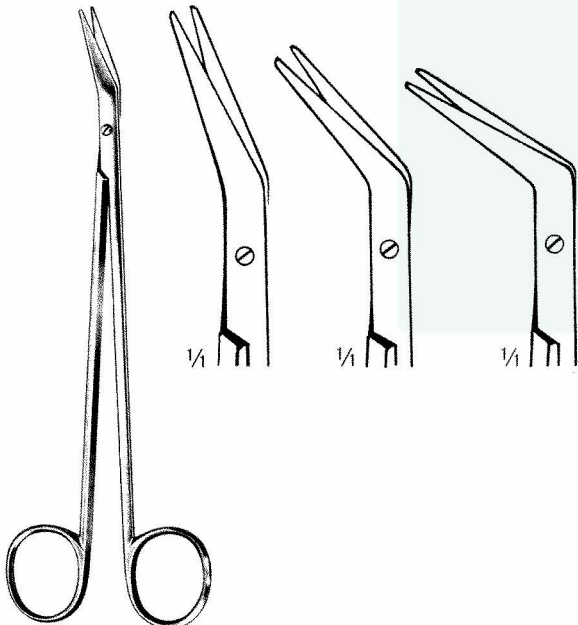

cm	DE BAKEY	25°	45°	60°
16		11.1236	11.1239	11.1242
23		11.1237	11.1240	11.1243
28		11.1238	11.1241	11.1244

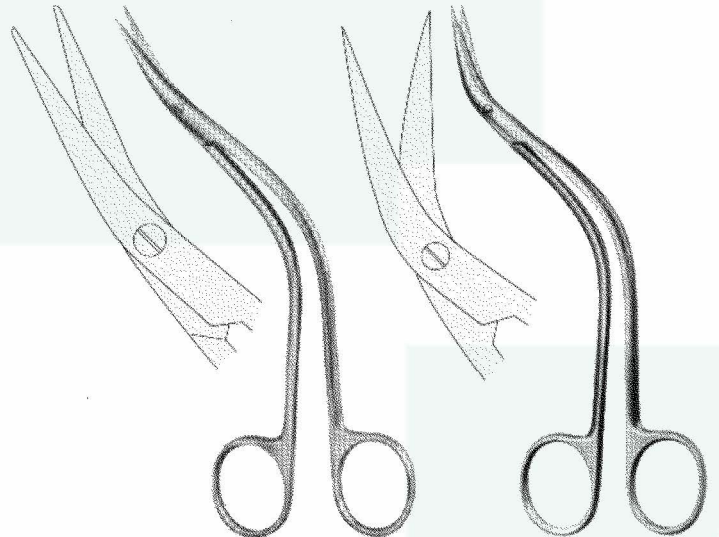

DEBAKEY  
 11.0950  
 16 cm 25°

DEBAKEY  
 11.0951  
 16 cm 45°

Verband-Scheren, Gipsverband  
 Bandage Scissors, Plaster of Paris  
 Ciseaux a bandages, appareils platr  
 Tijeras para vendajes, enyesados  
 Forbici per bendaggi gessati

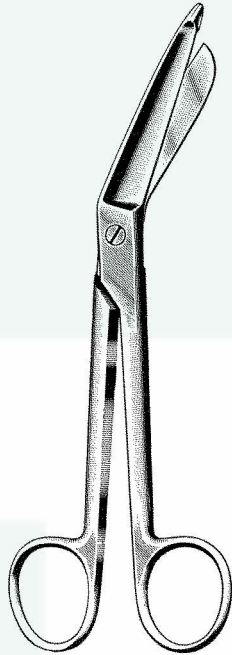

cm	LISTER
11	11.1250
14	11.1251
18	11.1252
20	11.1253

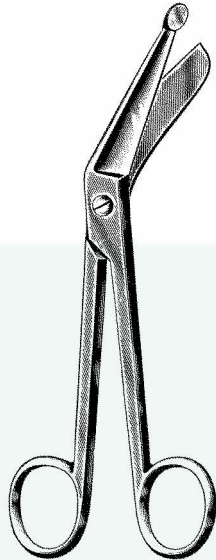

	BERGMANN
	11.1254
	23cm

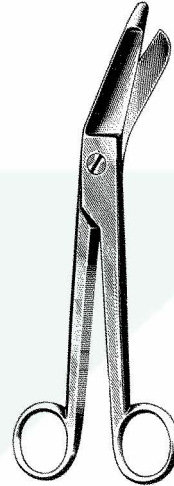

cm	ESMARCH
20	11.1255
22	11.1256



cm	UNIVERSAL
15	11.1257
18	11.1258

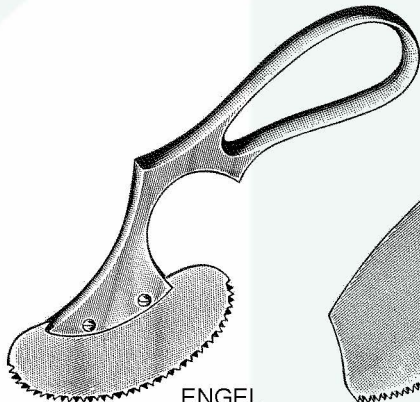

ENGEL  
 11.1259



BERGMANN  
 11.1260



cm	STILLE
23	11.1261
26	11.1262
37	11.1263

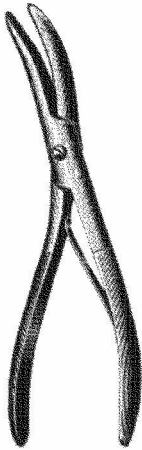

**WOLFF**  
 11.1264 18 cm

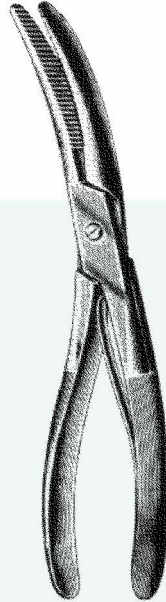

**WOLFF**  
 11.1265 24 cm

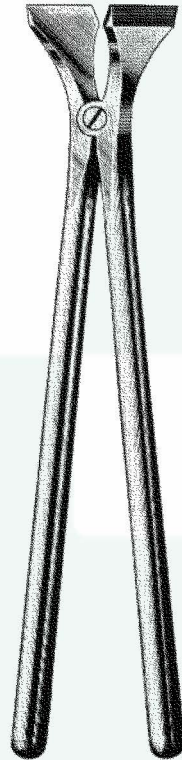

**BEESON**  
 11.1266 36 cm

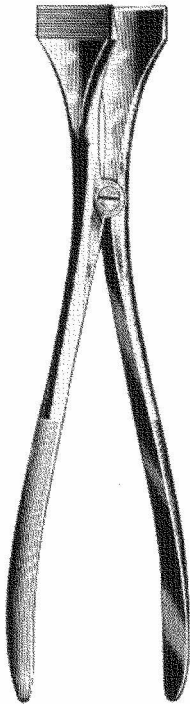

**BEESON**  
 11.1267 27 cm

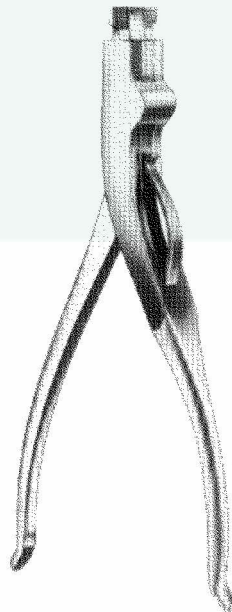

**WALTON**  
 11.1268 23 cm

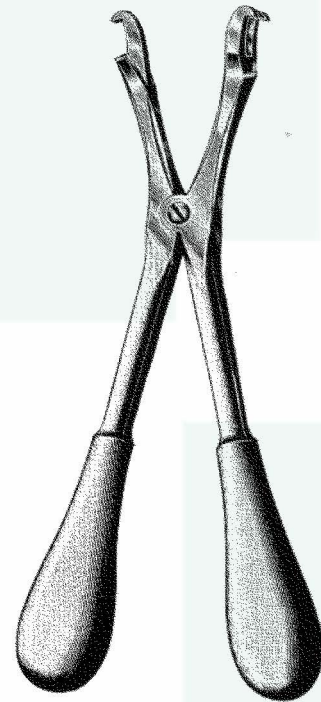

**STILLE-HAGLUND**  
 11.1269 28 cm

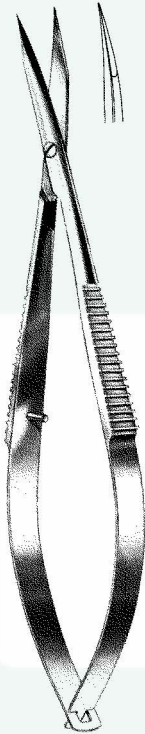

**WESTCOTT**  
 11.1270  
 11 cm

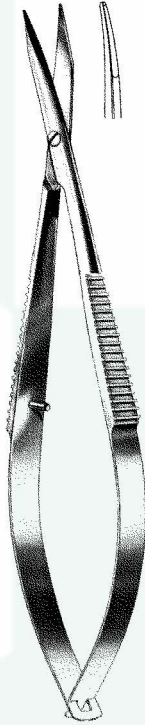

**WESTCOTT**  
 11.1271  
 11 cm

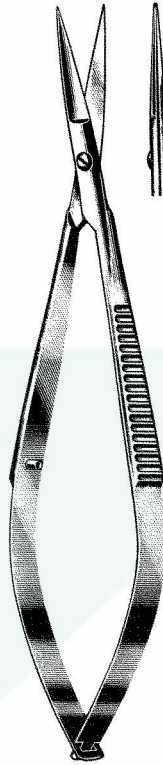

**NOYES**  
 11.1272  
 12 cm

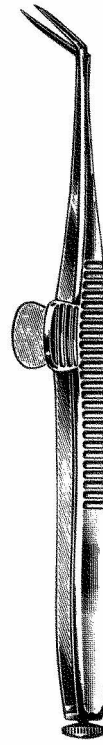

**WECKER**  
 11.1273 - 11.1275  
 11 cm



11.1273



11.1274

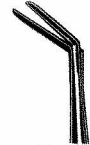

11.1275

Iridektomie  
 Iridectomy  
 Iridectomia

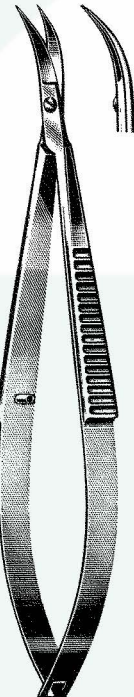

**CASTROVIEJO**  
 11.1276  
 10 cm

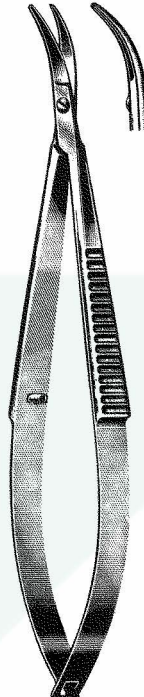

**CASTROVIEJO**  
 11.1277  
 10 cm

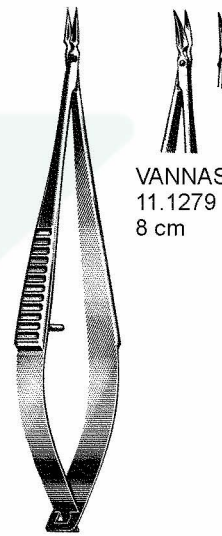

**VANNAS**  
 11.1279  
 8 cm

**VANNAS**  
 11.1278  
 8 cm

Pinzetten  
Thumb and Tissue Forceps  
Pincès à dissection  
Pinzas de disección  
Pinze per dissezione

cm			ADSON	POTTS-SMITH	POTTS-SMITH	CUSHING
11.5	11.2000					
12.0			11.2020			
13.0	11.2001	11.2010				
14.5	11.2002	11.2011				
15.0		11.2012				
16.0	11.2003		11.2021			
18.0	11.2004	11.2013				
20.0	11.2005			11.2030	11.2040	
25.0	11.2006			11.2031	11.2041	
30.0	11.2007			11.2032	11.2042	

schmal  
narrow  
étroite  
estrecha  
stretta

1:2

11.2050  
17 cm

schmal  
 narrow  
 étroite  
 estrecha  
 stretta

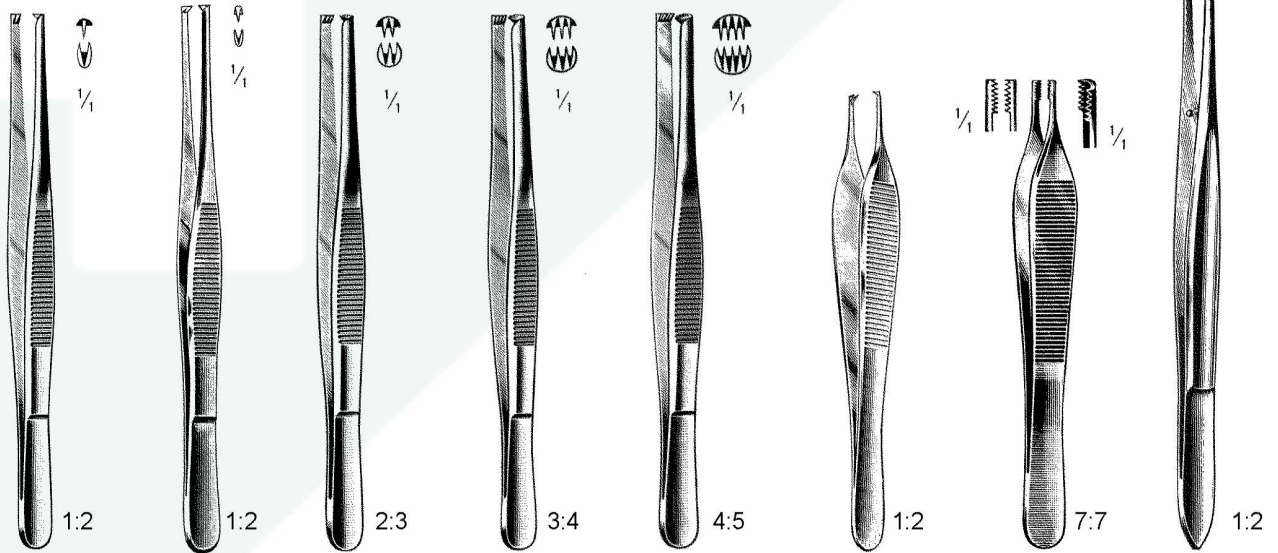

cm

cm	ADSON	ADSON-BROWN	CUSHING
11,5	11.2060		11.2130
12,0			17 cm
13,0	11.2061	11.2070	
14,5	11.2062	11.2071	
15,0			
16,0	11.2063	11.2072	
18,0	11.2064		
20,0	11.2065		
21,0			
25,0	11.2066		
30,0	11.2067		

Pinzetten  
 Thumb Tissue Splinter Forceps  
 Pincés à dissection  
 Pinzas de disección  
 Pinze per dissezione

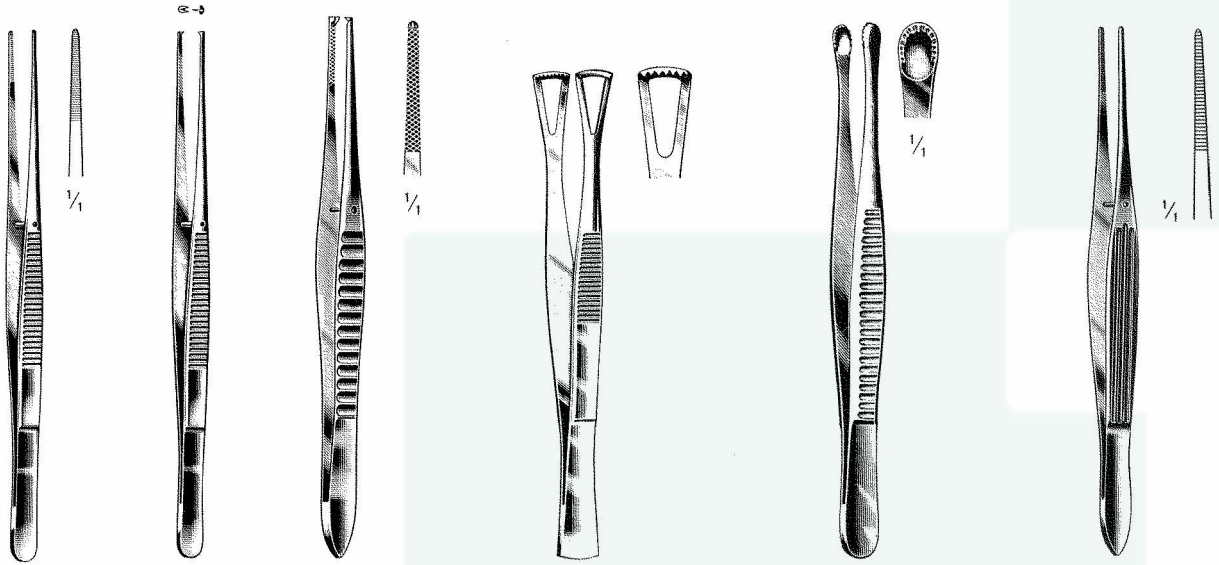

12,5 11.2140  
 15,5 11.2141  
 18,0

11.2142  
 11.2143  
 11.2144

14,5 11.2145  
 15,0  
 20,0  
 25,0

11.2146  
 11.2147  
 11.2148

11.2149

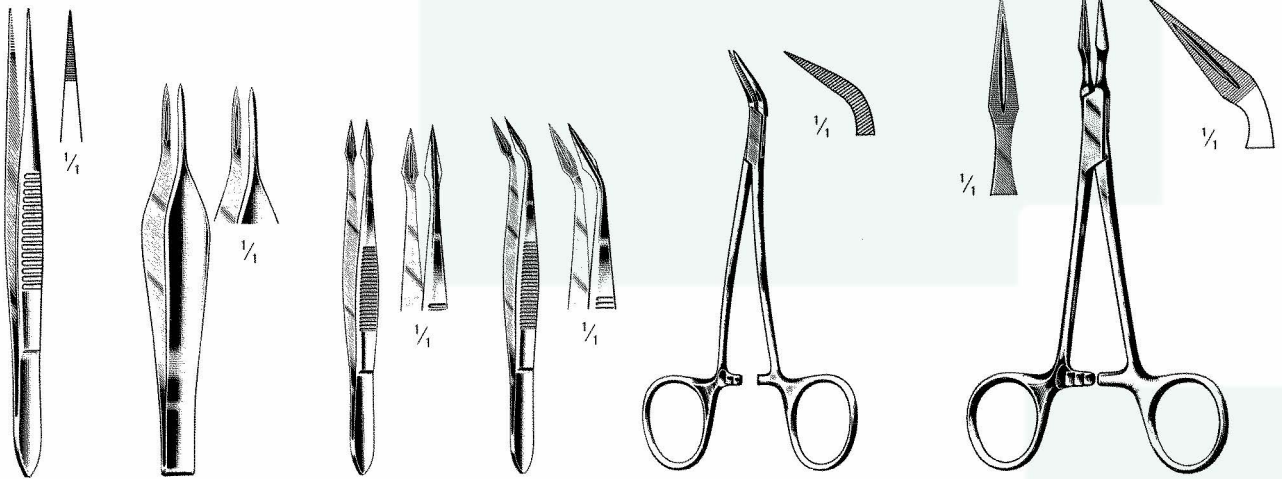

7.5  
 9.0 11.2150  
 10.5

11.2152

11.2151  
 11.2153

11.2154  
 11.2155

11.2156  
 11,5 cm

11.2157 13,5 cm 11.2158

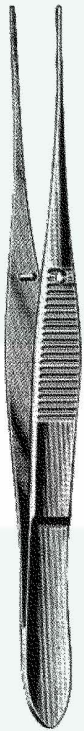

GRAEFE  
 11.0010 10 cm

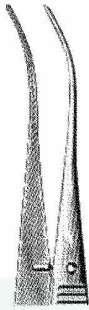

GRAEFE  
 11.0011 10 cm

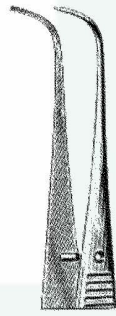

GRAEFE  
 11.0012 10 cm

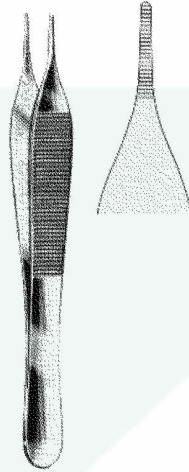

EWALD  
 11.0013 10 cm



ADSON  
 11.0014 10 cm



CUSHING  
 11.0015 18 cm



CUSHING  
 11.0016 18 cm

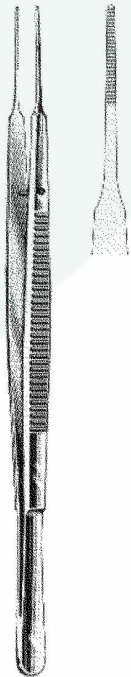

GERALD  
 11.0017 18 cm

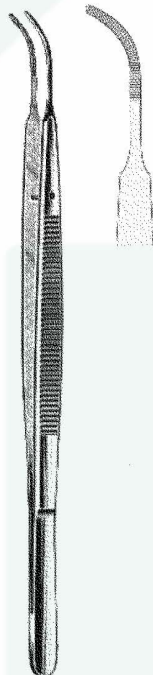

GERALD  
 11.0018 18 cm

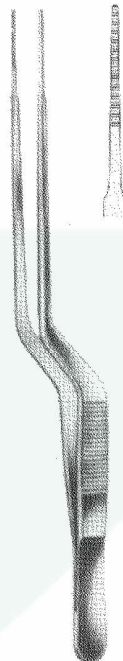

GERALD  
 11.0019 18 cm



DEBAKEY-GERALD  
 11.0020 18 cm

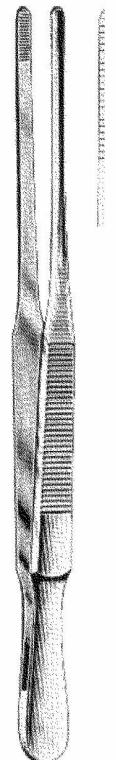

DUEHRSEN  
 11.0021 20 cm

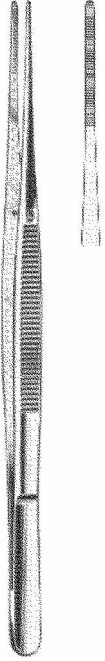

TAYLOR  
 11.0022 18 cm



TAYLOR  
 11.0023 18 cm



TAYLOR  
 11.0024 18 cm



TAYLOR  
 11.0025 18 cm



TAYLOR-CUSHING  
 11.0026 18 cm



TAYLOR-CUSHING  
 11.0027 18 cm

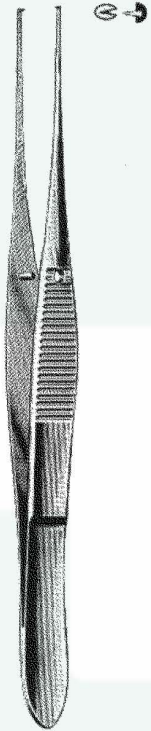

GRAEFE  
 11.0028  
 10 cm 1X2

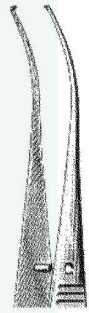

11.0029  
 10 cm 1X2

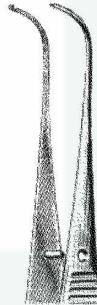

11.0030  
 10 cm 1X2

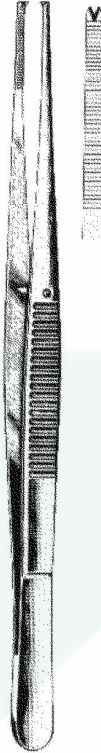

BROPHY  
 11.0042 20 cm 1x2

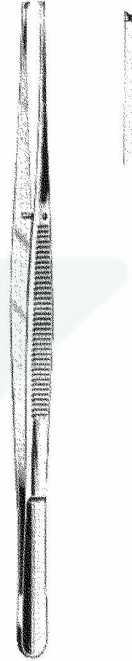

TAYLOR  
 11.0048 18 cm



TAYLOR  
 11.0049 18 cm



TAYLOR-CUSHING  
 11.0051 18 cm

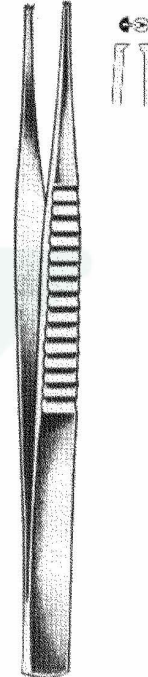

TREVES  
 11.0056 13 cm 1x2  
 11.0057 15 cm 1x2

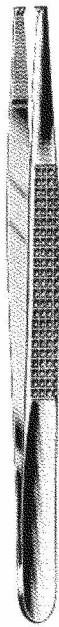

BONNEY  
11.0060  
18 cm 1x2



BONNEY  
11.0061  
18 cm 2x3



NELSON  
11.0062 15 cm  
11.0063 20 cm  
11.0064 23 cm

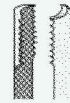

BROWN  
11.0065 15 cm  
11.0066 20 cm  
11.0067 23 cm



LANE  
11.0068 14.5 cm 1x2  
11.0069 20 cm 1x2



RUSSIAN  
11.0070 15 cm 2x3  
11.0071 20 cm 2x3  
11.0072 25 cm 2x3

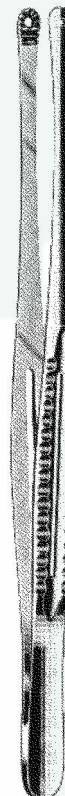

MAYO-RUSSIAN  
11.0073 23 cm

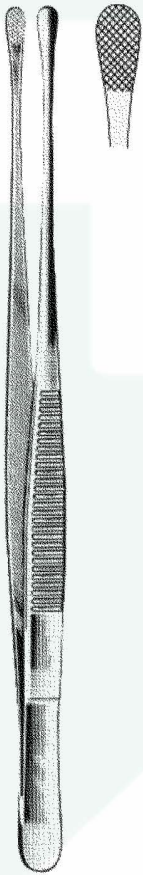

**WANGENSTEEN**  
 11.0075 23 cm

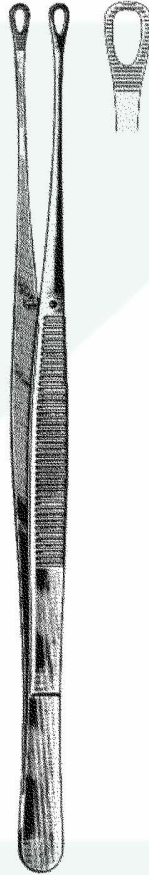

**SINGLEY (TUTTLE)**  
 11.0076 15 cm  
 11.0077 18 cm  
 11.0078 23 cm

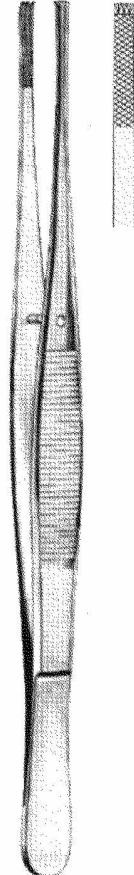

**STILLE-BARRAYA**  
 11.0079 18 cm  
 11.0080 20 cm  
 11.0081 25 cm

Atraumatische Pinzetten  
 Non-Traumatic Tissue Forceps  
 Pincers Amors Non-Traumatisants  
 Pinzas Con Bocas Atraumaticas  
 Pinze Atraumatiche

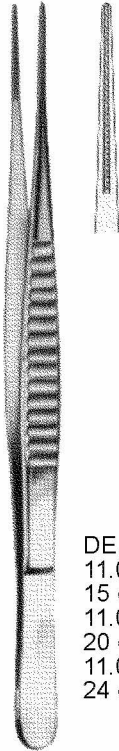

DEBAKEY  
 11.0082  
 15 cm / 1.5 mm  
 11.0083  
 20 cm / 1.5 mm  
 11.0084  
 24 cm / 1.5 mm

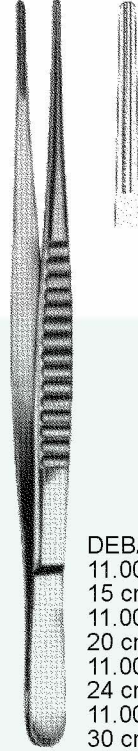

DEBAKEY  
 11.0088  
 15 cm / 2 mm  
 11.0089  
 20 cm / 2 mm  
 11.0090  
 24 cm / 2 mm  
 11.0091  
 30 cm / 2 mm

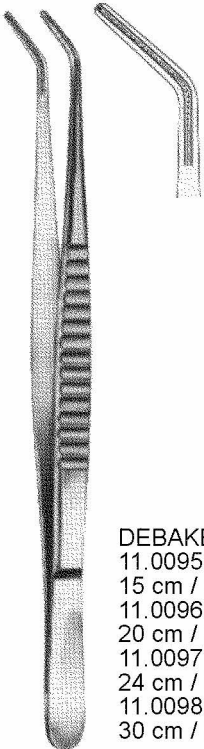

DEBAKEY  
 11.0095  
 15 cm / 2 mm  
 11.0096  
 20 cm / 2 mm  
 11.0097  
 24 cm / 2 mm  
 11.0098  
 30 cm / 2 mm

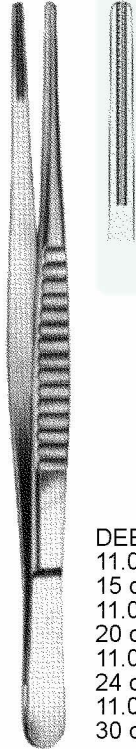

DEBAKEY  
 11.0099  
 15 cm / 2.7 mm  
 11.0100  
 20 cm / 2.7 mm  
 11.0101  
 24 cm / 2.7 mm  
 11.0102  
 30 cm / 2.7 mm

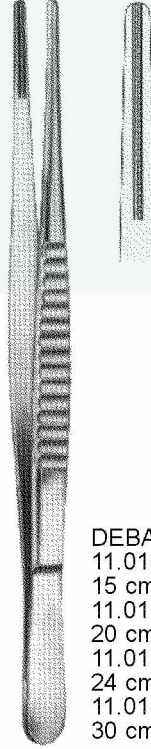

DEBAKEY  
 11.0103  
 15 cm / 3.5 mm  
 11.0104  
 20 cm / 3.5 mm  
 11.0105  
 24 cm / 3.5 mm  
 11.0106  
 30 cm / 3.5 mm

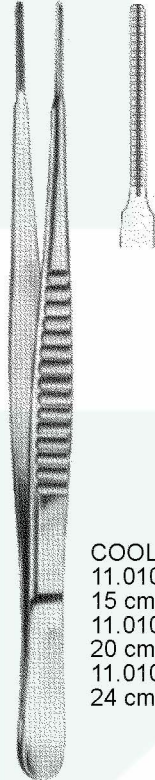

COOLEY  
 11.0107  
 15 cm / 2 mm  
 11.0108  
 20 cm / 2 mm  
 11.0109  
 24 cm / 2 mm

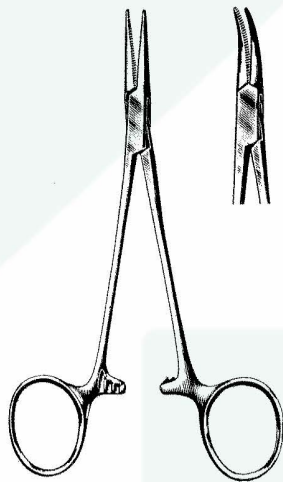
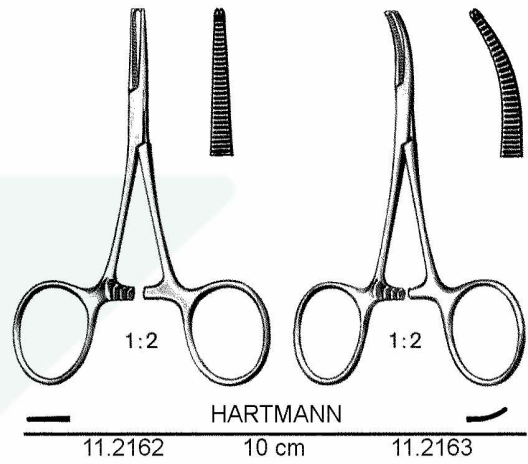
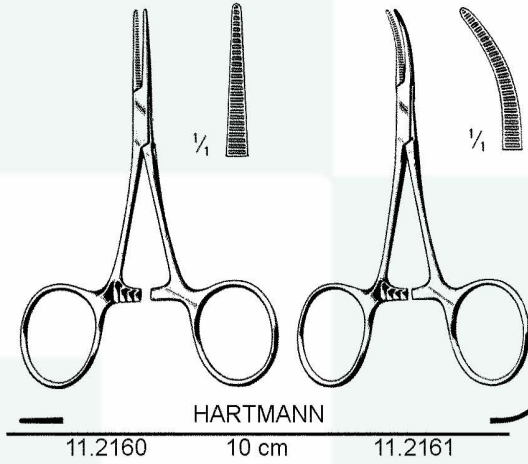

cm	HALSTED-MOSQUITO	
12.5	11.2170	11.2174
14.0	11.2171	11.2175
18.0	11.2172	11.2176
21.0	11.2173	11.2177

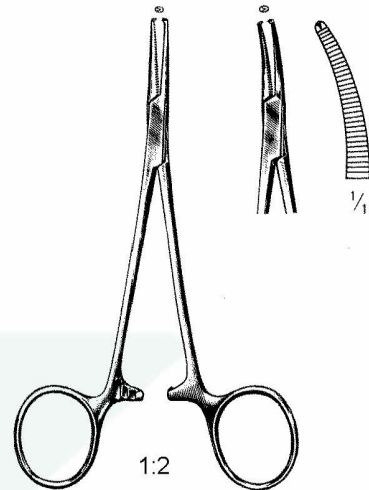

cm	HALSTED-MOSQUITO	
12.5	11.2178	11.2182
14.0	11.2179	11.2183
18.0	11.2180	11.2184
21.0	11.2181	11.2185

Arterienklemmen  
 Hemostatic Forceps  
 Pinces hémostatiques  
 Pinzas hemostáticas  
 Pinze emostatiche

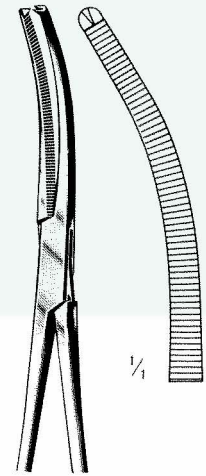
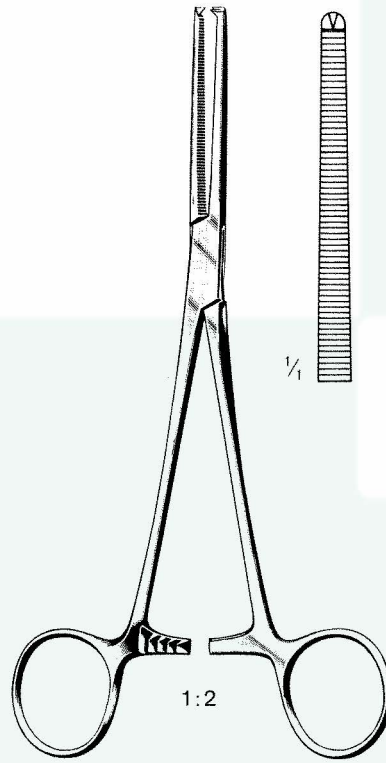
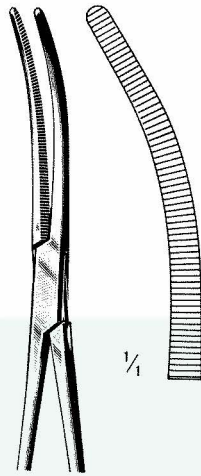
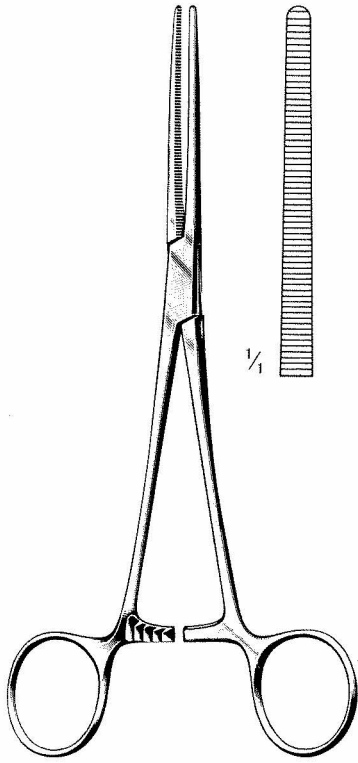

cm	ROCHESTER-PEAN	
13	11.2190	11.2200
14	11.2191	11.2201
16	11.2192	11.2202
18	11.2193	11.2203
20	11.2194	11.2204
22	11.2195	11.2205
24	11.2196	11.2206
26	11.2197	11.2207
30	11.2198	11.2208

cm	ROCHESTER-OSHSNER	
13	11.2210	11.2220
14	11.2211	11.2221
16	11.2212	11.2222
18	11.2213	11.2223
20	11.2214	11.2224
22	11.2215	11.2225
24	11.2216	11.2226
26	11.2217	11.2227
30	11.2218	11.2228

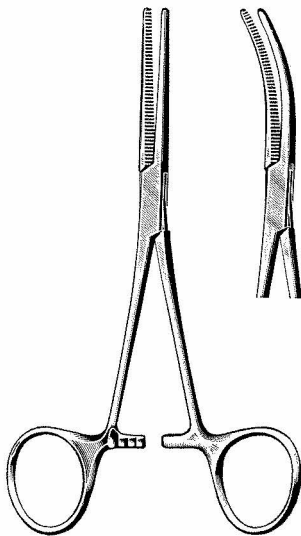

Graziles Modell  
 Delicate Model  
 Modèle délicat  
 Modelo delgado  
 Modello delicato

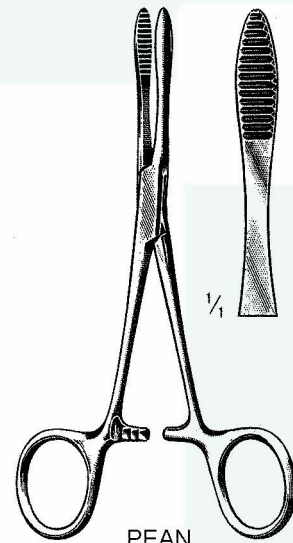

PEAN  
 11.2230 14 cm 11.2231

PEAN  
 11.2232 14 cm  
 11.2233 16 cm

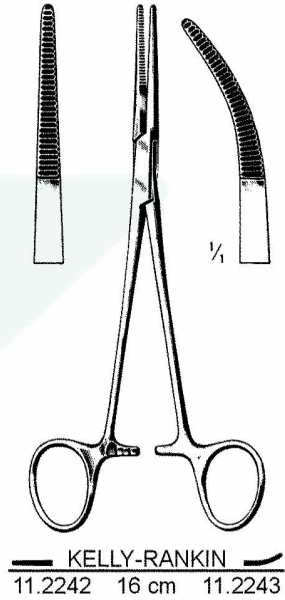
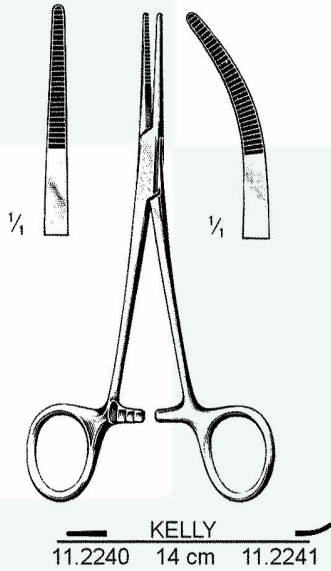

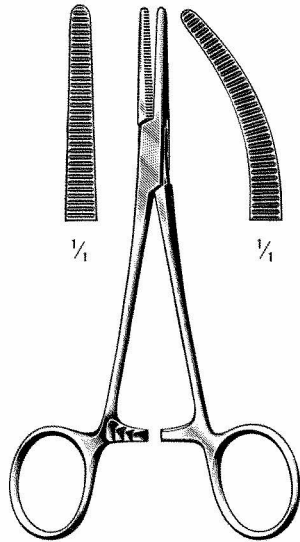

**SPENCER-WELLS**  
 11.2260 13cm 11.2264  
 11.2261 15cm 11.2265  
 11.2262 18cm 11.2266  
 11.2263 20cm 11.2267

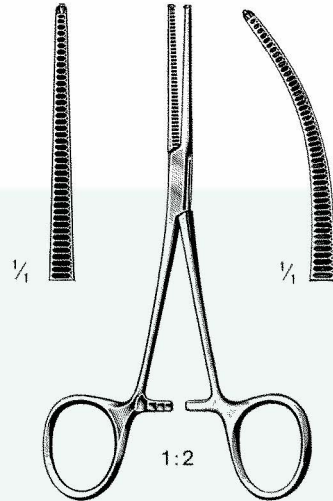

**KOCHER**  
 11.2270 14cm 11.2271

Graziles Modell  
 Delicate Model  
 Modèle délicat  
 Modelo delgado  
 Modello delicato

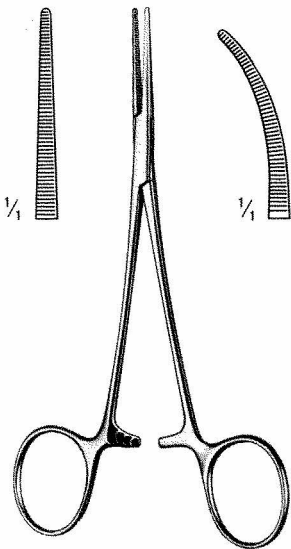

**LERICHE**  
 11.2280 15cm 11.2281

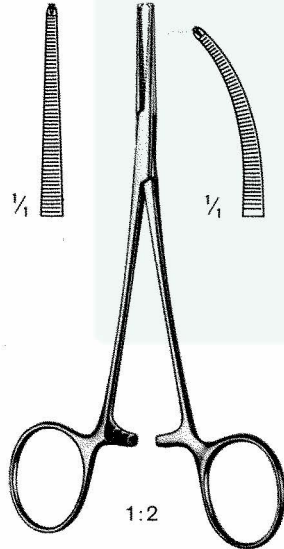

**LERICHE**  
 11.2282 15cm 11.2283

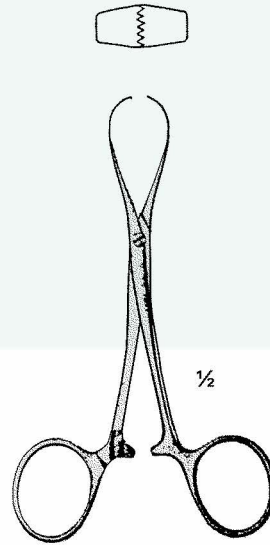

**OMBREDANNE**  
 11.2290  
 12,5 cm

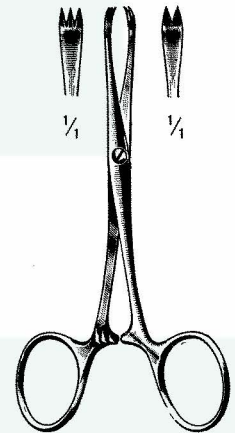

**CHAPUT**  
 11.2291  
 13 cm

Arterienklemmen  
 Hemostatic Forceps  
 Pinces hémostatiques  
 Pinzas hemostáticas  
 Pinze emostatiche

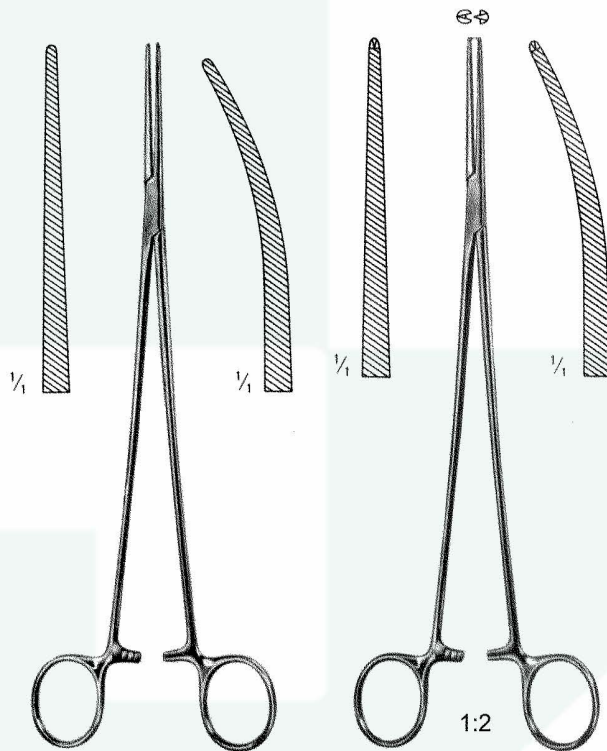

————— BENGOLEA ————— BENGOLEA —————  
 11.2300 20cm 11.2310 11.2320 20cm 11.2330  
 11.2301 26cm 11.2311 11.2321 26cm 11.2331

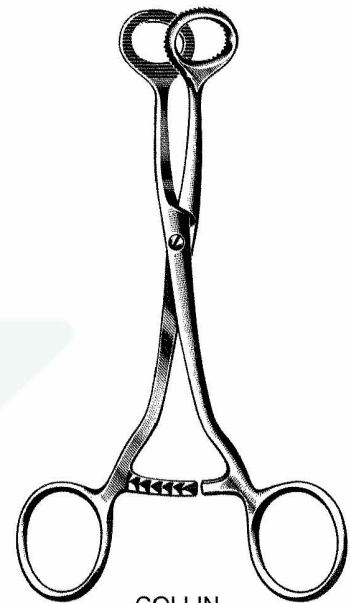

COLLIN  
 11.2340  
 16 cm

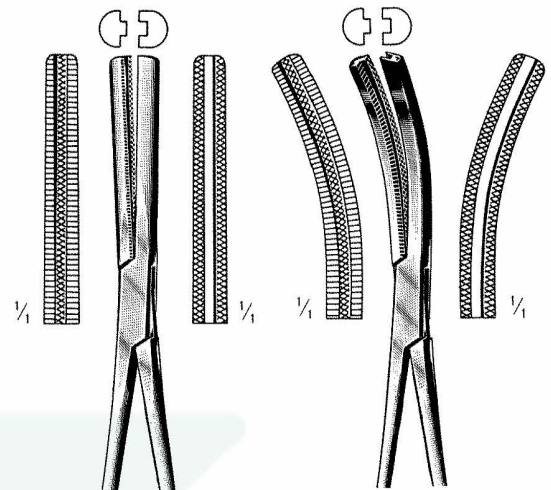

Druckklemmen · Angiotribes  
 Pinces-clamps à pression  
 progressive · Pinzas-clamps  
 para presión progresiva ·  
 Angiotribi

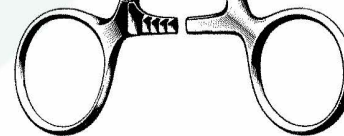

FERGUSSON

11.2350 16cm 11.2352  
 11.2351 20cm 11.2353

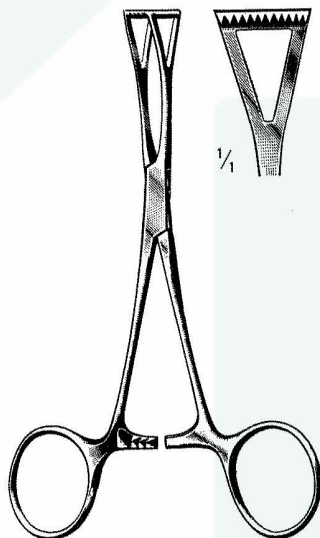

COLLIN  
 11.2341  
 14 cm

Arterien, Gallenkanal, Nierenstiel  
 Hemostatic, Gall Duct, and Kidney pedicle  
 Hémostatiques, pédicule rénal et voies biliaires  
 Hemostáticas, pedículo renal y vías biliares  
 Emostatiche, pedunculo renale e vie biliari

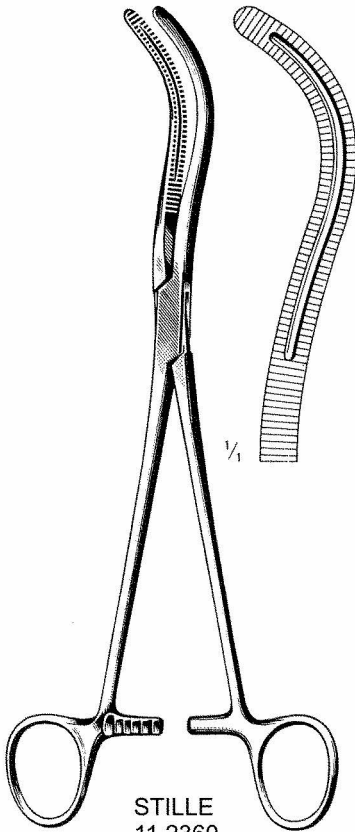

**STILLÉ**  
 11.2360  
 23 cm

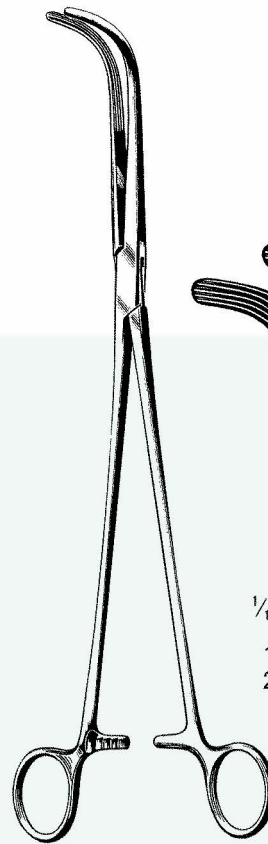

**MIXTER**  
 11.2361 - 11.2363

11.2361 22 cm  
 11.2362 25 cm  
 11.2363 28 cm

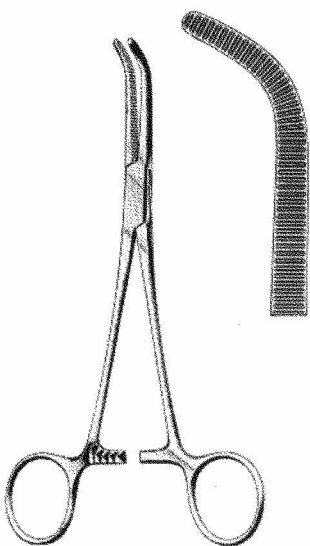

**MIXTER-O'SHAUGHNESSY**  
 11.2366 15 cm  
 11.2367 19 cm

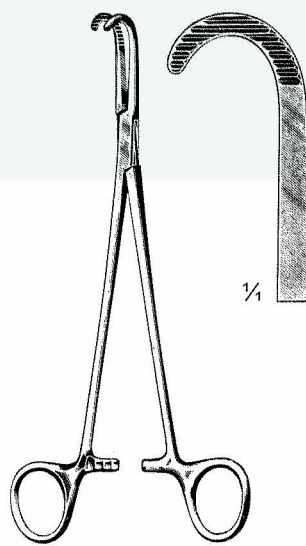

**DESJARDINS**  
 11.2364  
 21 cm

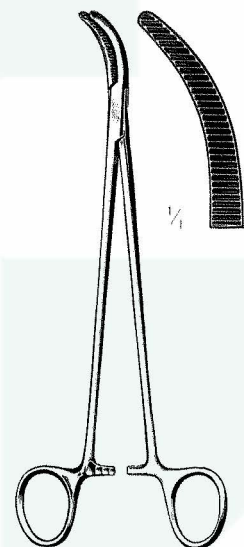

**DESJARDINS**  
 11.2365  
 21 cm

Hysterektomie-Klemmen  
 Hysterectomy Forceps  
 Pinces à hysterectomie  
 Pinzas para hysterectomia  
 Pinze per isterectomia

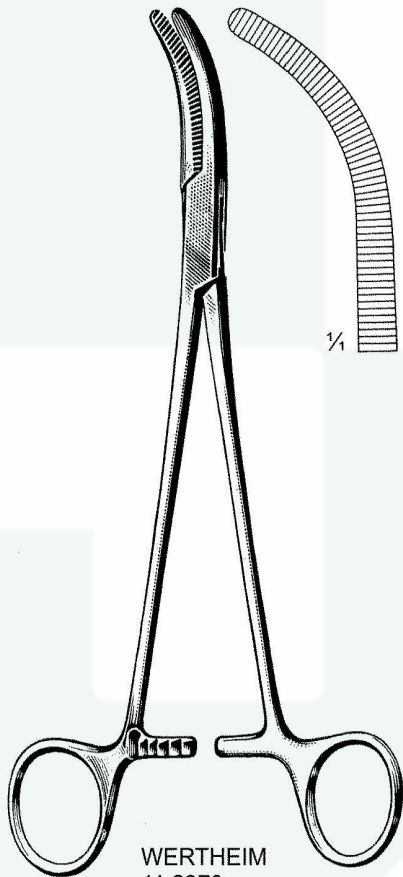

WERTHEIM  
 11.2370  
 25 cm

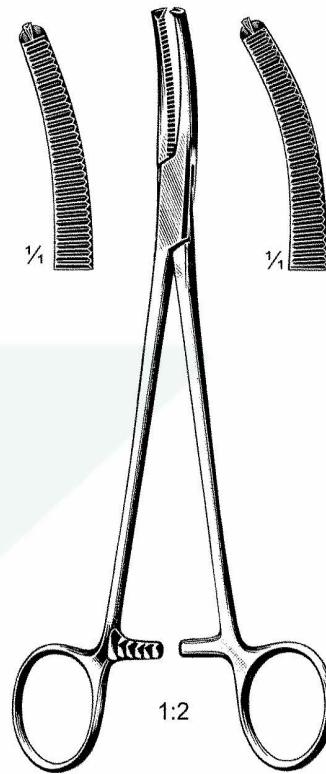

WERTHEIM  
 11.2371 22cm 11.2372  
 23cm



HEANEY  
 11.2373  
 20 cm

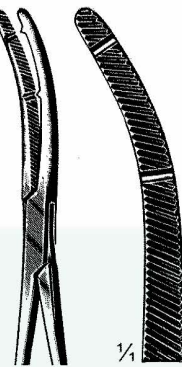

11.2374  
 20 cm

Peritoneum-Klemmen  
 Peritoneum Forceps  
 Pinces à péritoine  
 Pinzas para peritoneo  
 Pinze peritoneali

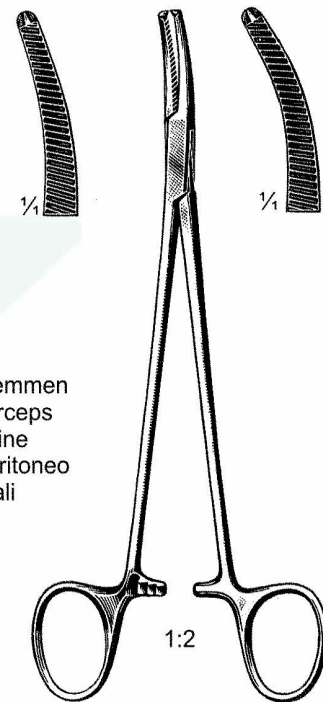

FAURE  
 11.2375 20cm 11.2376

Tuchklemmen  
 Towel Forceps  
 Pincès à champs  
 Pinzas para campos  
 Pinze fissateli

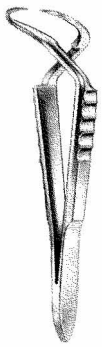

**JONES**  
 11.2380  
 9 cm

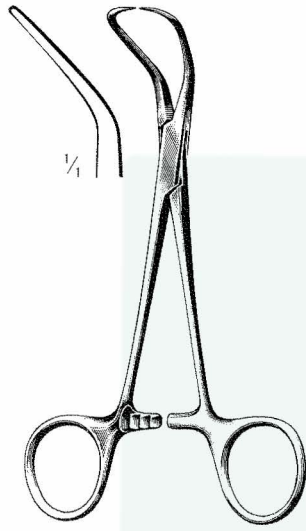

cm	BACKHAUS
9	11.2390
11	11.2391
13	11.2392

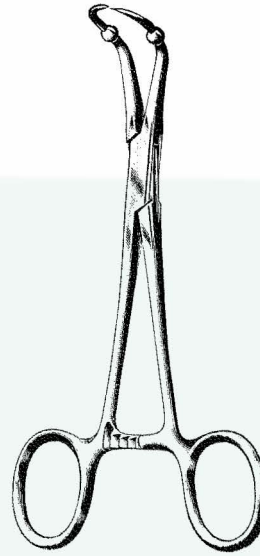

**ROEDER**  
 11.2381  
 13 cm



**DOYEN**  
 11.2382  
 18 cm

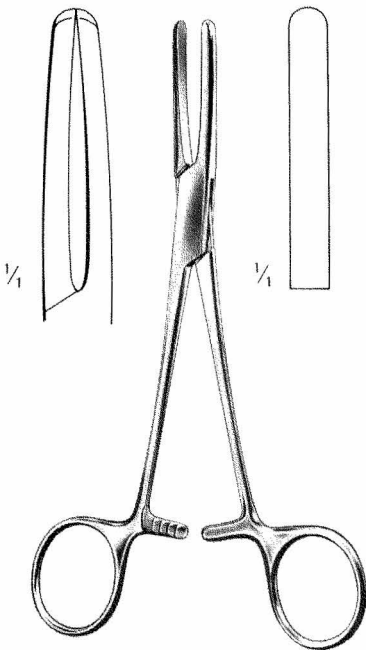

11.2400 16 cm  
 11.2401 18 cm

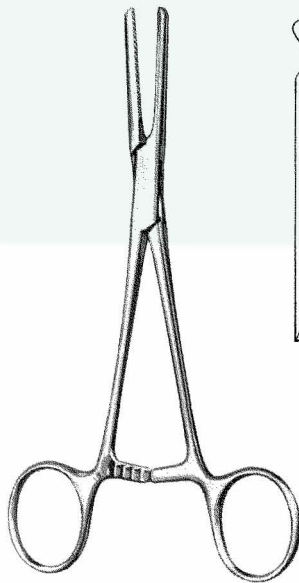

11.2402-11.2404

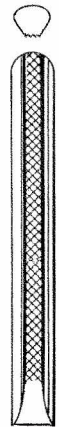
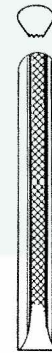
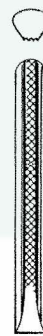

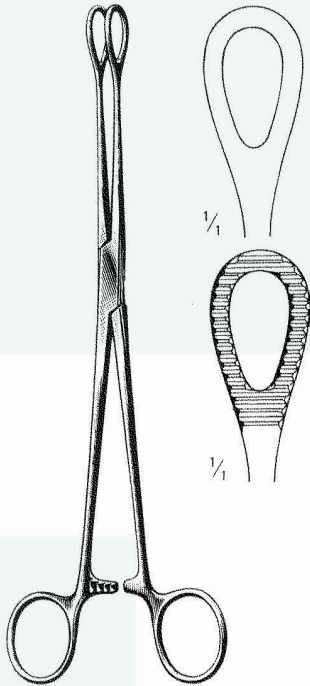

FOERSTER

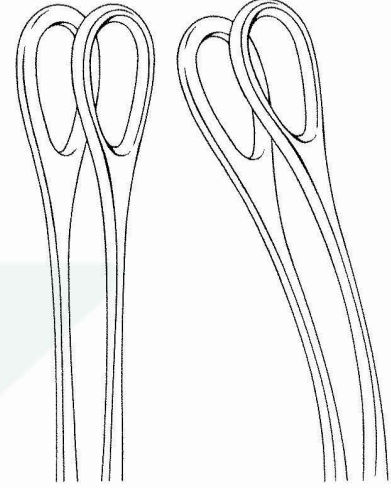
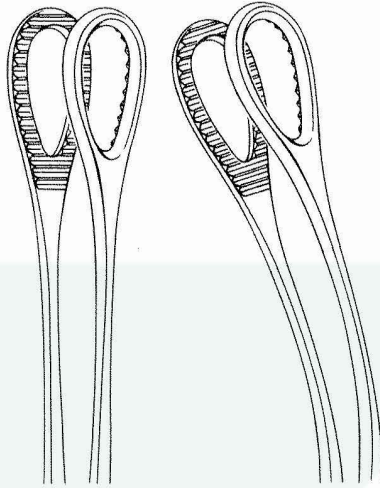

		cm		
11.2410	11.2420	18	11.2430	11.2440
11.2411	11.2421	20		
11.2412	11.2422	25	11.2431	11.2441

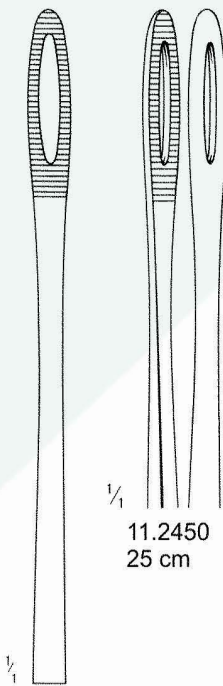

11.2450  
25 cm

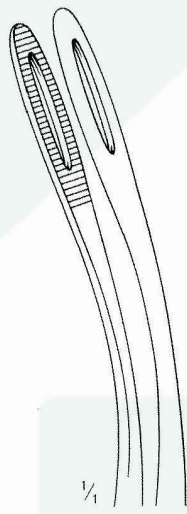

11.2451  
25 cm

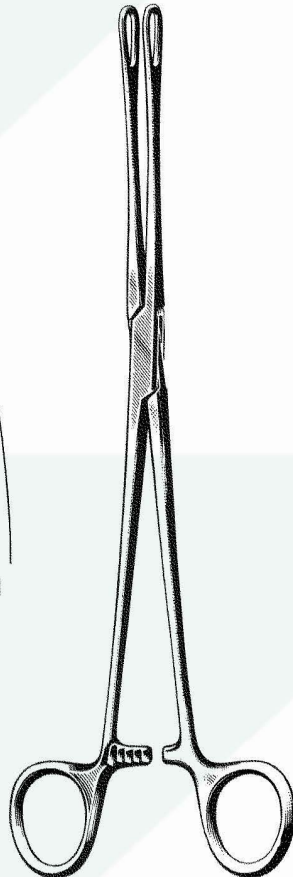

FOERSTER

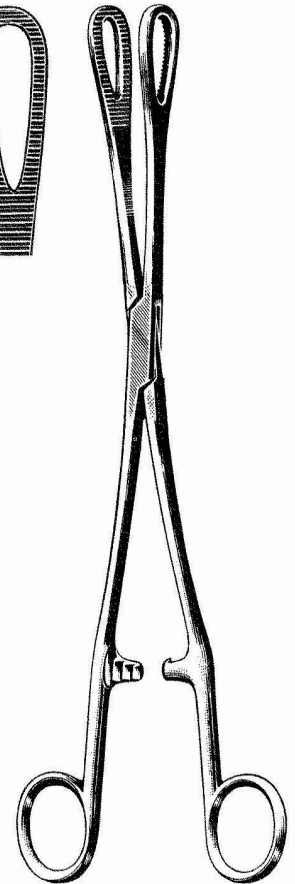
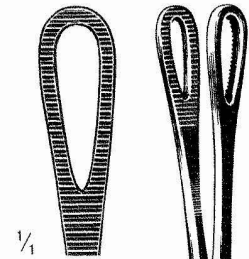

RAMPLEY  
11.2460  
25 cm

Schwammzangen  
 Dressing Forceps  
 Pincès à polypes  
 Pinzas para tapones  
 Pinze per tamponi

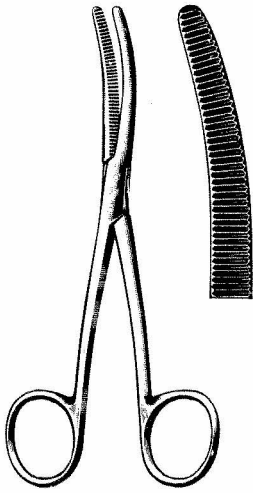

**BRYANT**  
 11.2461  
 13 cm

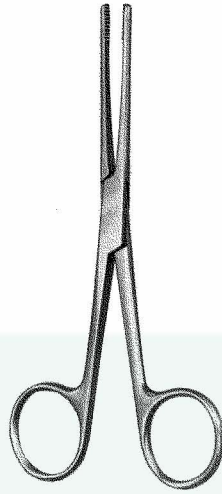

cm	LISTER (Sinus)
13	11.2462
16	11.2463
18	11.2464

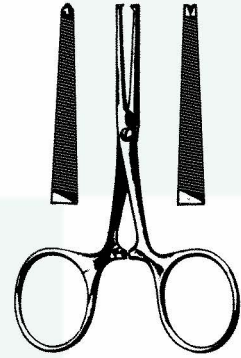

cm	Terrier
8.5	11.9692

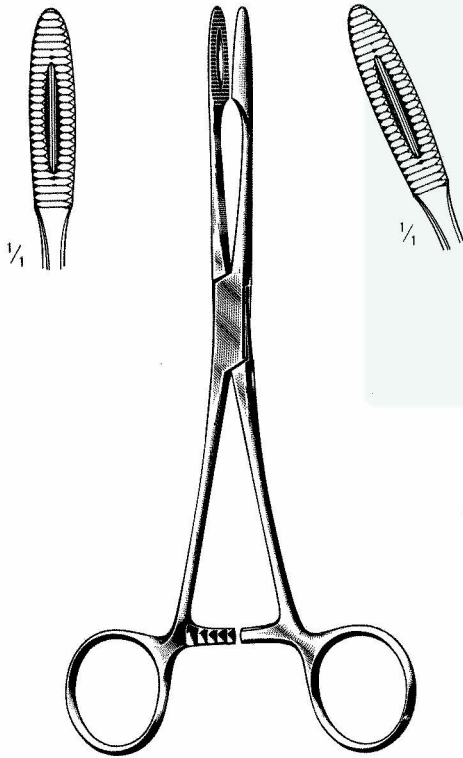

GROSS-MAIER		
11.2465	20 cm	11.2467
11.2466	25 cm	11.2468

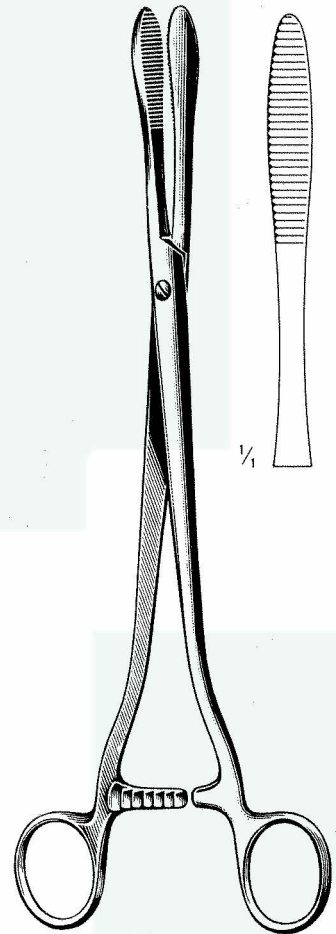

**COLLIN**  
 11.2469  
 25 cm

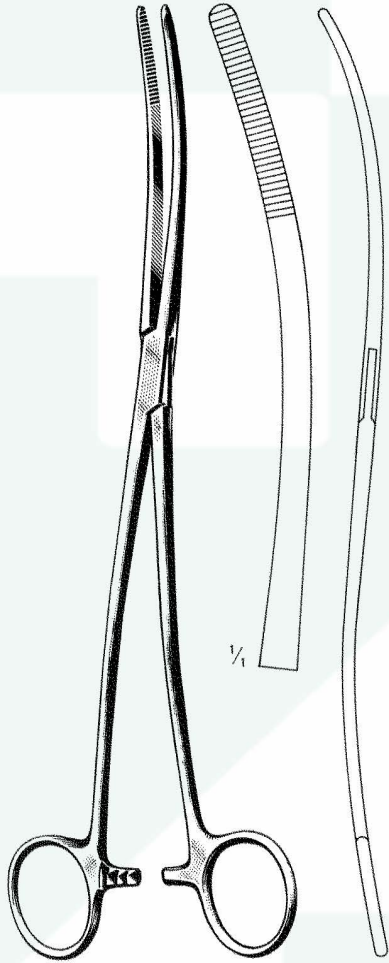

BOZEMAN

11.2470 26 cm 11.2471

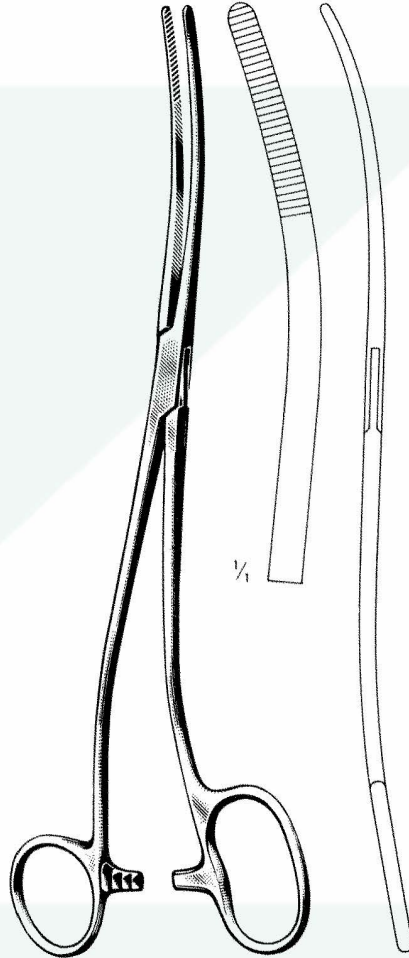

BOZEMANN-DOUGLAS

11.2472  
26 cm

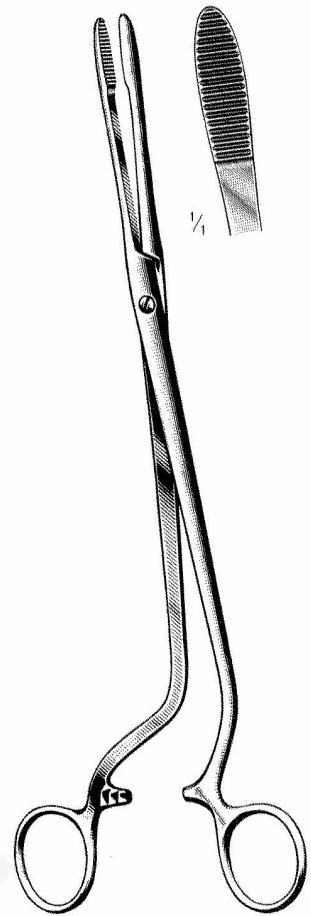

CHERON

11.2473  
25 cm

Arterienklemmen  
 Hemostatic Forceps  
 Pinces hémostatiques  
 Pinzas hemostáticas  
 Pinze emostatiche

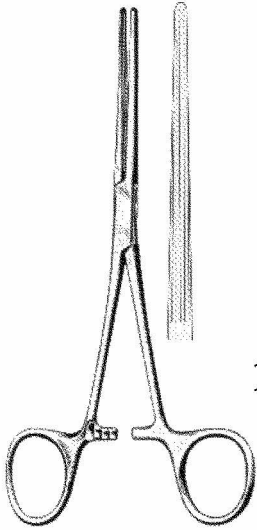

11.2501 15.5 cm  
 11.2502 18 cm

**BAINBRIDGE**  
 11.2499 15.5 cm  
 11.2500 18 cm

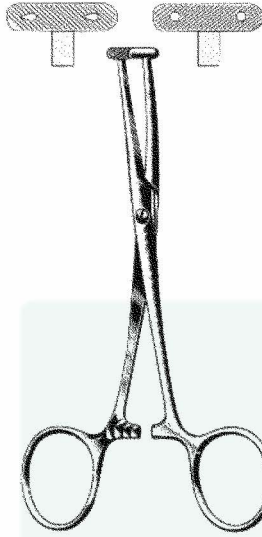

**MARTEL**  
 11.2503 14 cm



**WILLET**  
 11.2504 19 cm

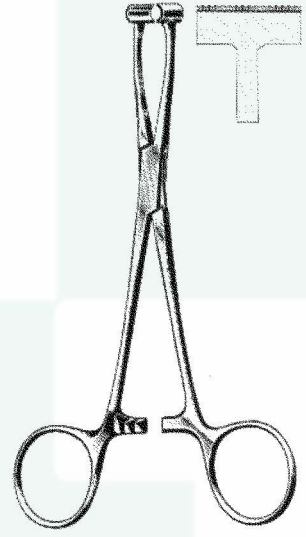

**PRATT**  
 11.2505 15 cm

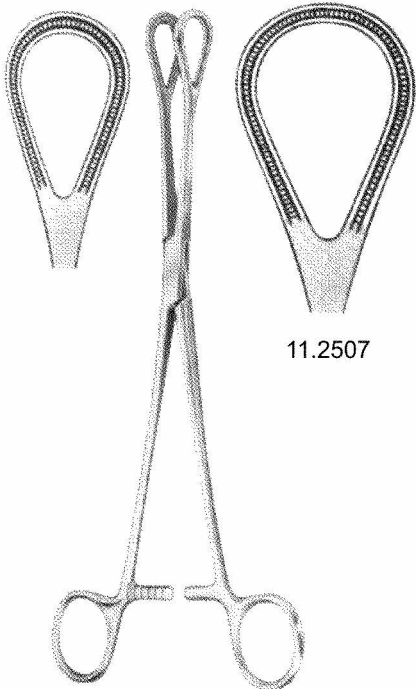

11.2507

**DEBAKEY**  
 11.2506 25 cm

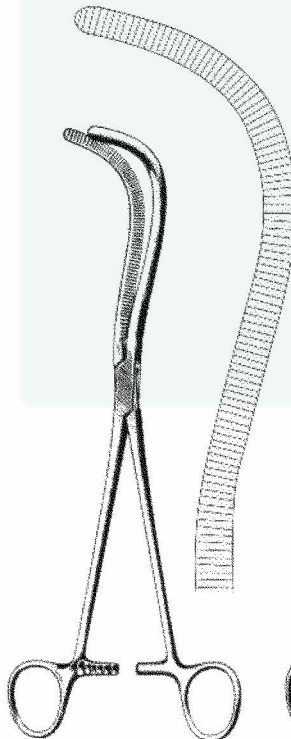

**MAYO**  
 11.2508 23 cm

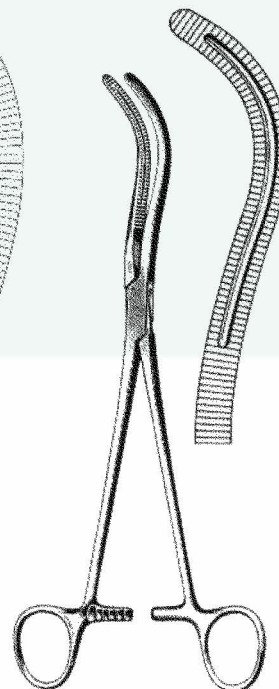

**STILLE**  
 11.2509 23 cm

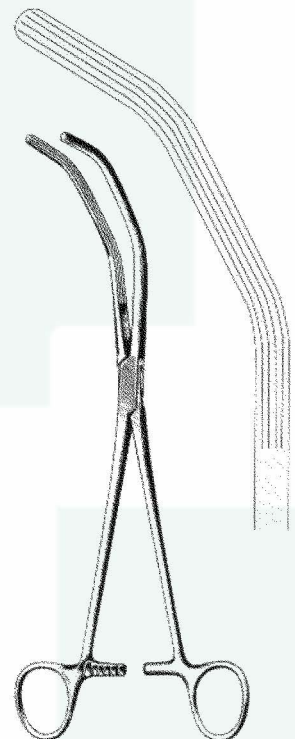

**HERRICK**  
 11.2510 23 cm

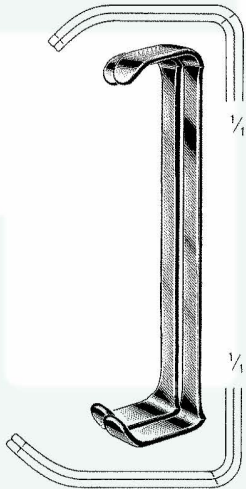

**FARABEU**  
 11.3000  
 12 cm

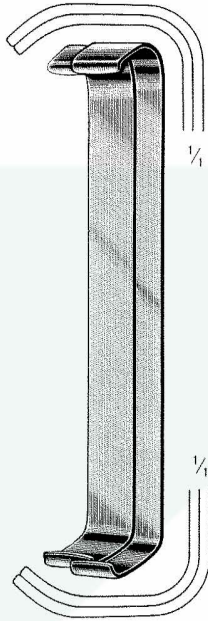

**FARABEU**  
 11.3001  
 15 cm

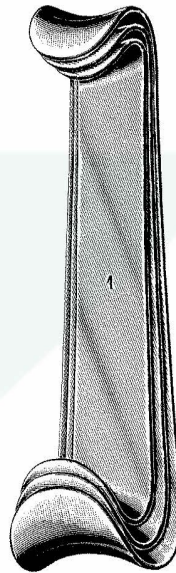

**ROUX**  
 11.3002  
 14 cm

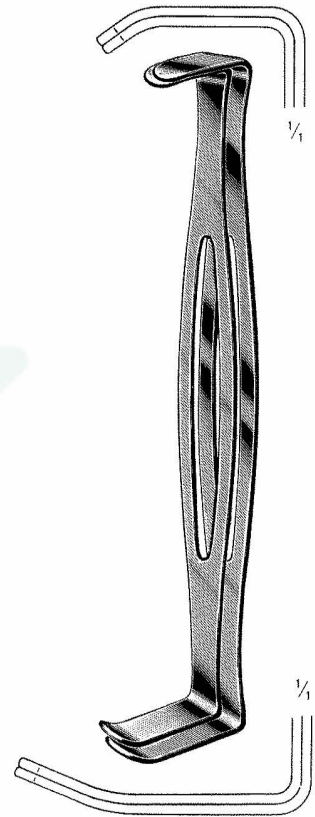

**US Army (PARKER-LANGENBECK)**  
 11.3003  
 21 cm

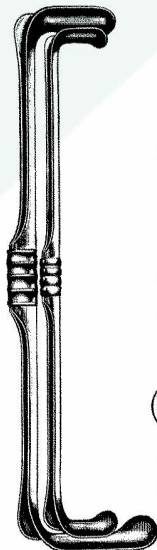

**RICHARDSON-EASTMAN**  
 11.3004



11.3005  
 28x20 mm



11.3006  
 36x28 mm

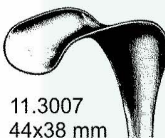

11.3007  
 44x38 mm

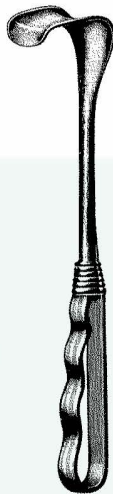

**RICHARDSON**



**RICHARDSON Grip**  
 11.3008 20x25mm  
 11.3009 25x31mm  
 11.3010 38x38mm  
 11.3011 19x51mm(Append)  
 11.3012 41x64mm



**KELLY**  
 11.3013  
 26 cm

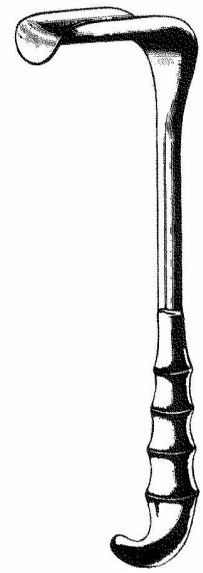

**KELLY GRIP**  
 11.3014 38x51 mm  
 11.3015 51x64 mm  
 11.3016 64x76 mm  
 11.3017 70x82 mm



Wundhaken  
Retractors  
Ecarteurs  
Separadores  
Divaricatori

DEAVER  
11.3020  
19x180 mm

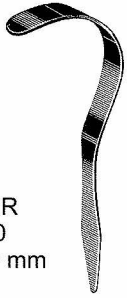

DEAVER  
11.3021  
22x215 mm

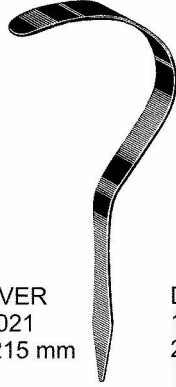

DEAVER  
11.3022  
25x230 mm

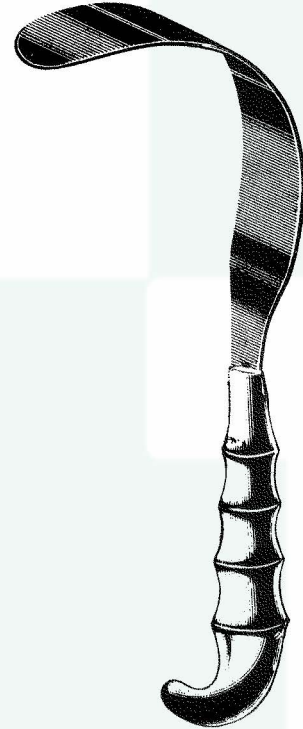
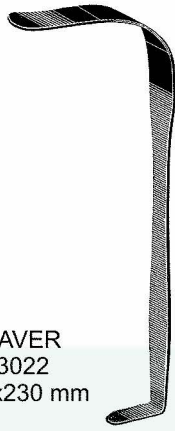

DEAVER Grip

11.3029	25x310 mm
11.3030	38x310 mm
11.3031	50x310 mm

DEAVER  
11.3023  
25x300 mm

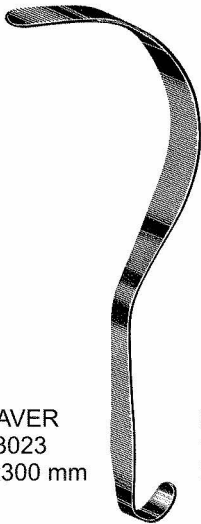

DEAVER  
11.3024  
25x330 mm



DEAVER  
11.3025  
25x360 mm

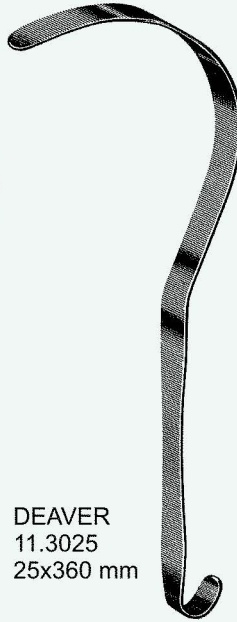

DEAVER  
11.3026  
38x300 mm

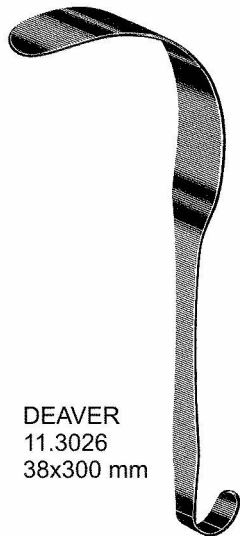

DEAVER  
11.3027  
50x300 mm

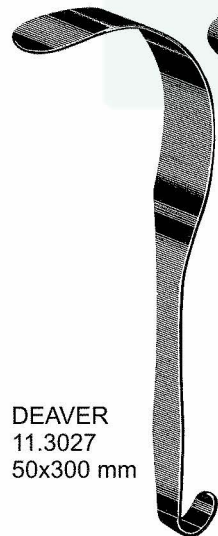

DEAVER  
11.3028  
75x300 mm

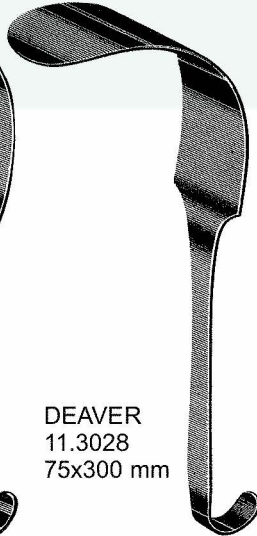

HARRINGTON

11.3032	25x230 mm
11.3033	40x320 mm
11.3034	62x320 mm



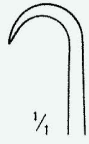

1/1



1/2

11.3040



1/2

11.3041



1/2

11.3042



1/2

11.3043



1/2

11.3044

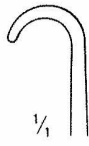

1/1



1/2

11.3045



1/2

11.3046



1/2

11.3047



1/2

11.3048



1/2

11.3049

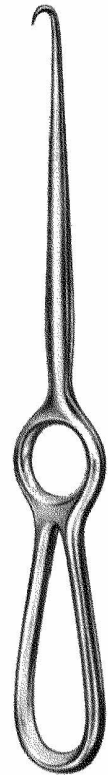

VOLKMANN  
21.5 cm



DESMARRES  
16 cm



1/1

11.3050  
12 mm



1/1

11.3051  
14 mm



1/1

11.3052  
16 mm



1/1

11.3053  
18 mm



1/1



CUSHING  
20 cm



1/1

11.3060  
8 mm



1/1

11.3061  
10 mm



1/1

11.3062  
12 mm



1/1

11.3063  
14 mm



1/1

11.3064  
16 mm



1/1

11.3065  
18 mm

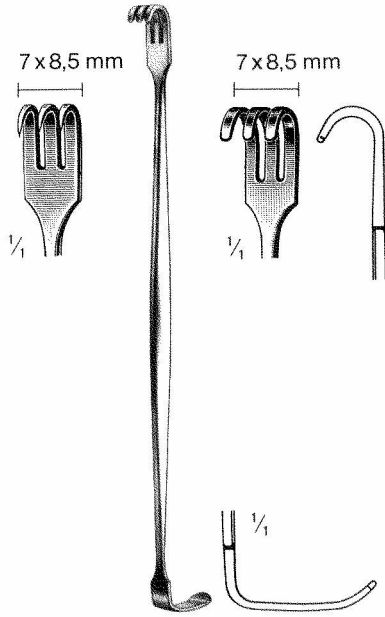

**SENN**  
 11.3070 17cm 11.3071

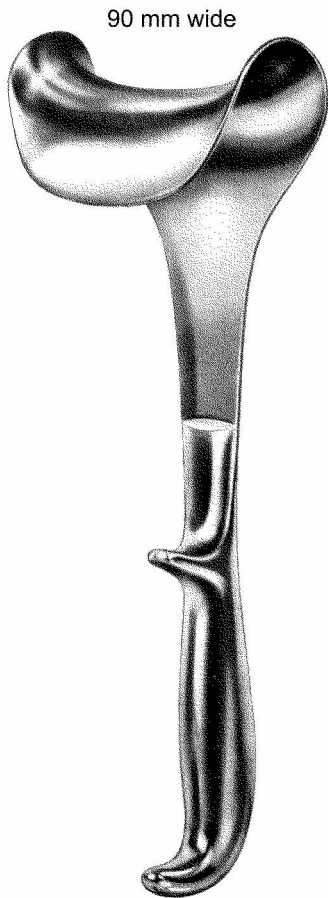

DOYEN  
 11.3080  
 25 cm



mm	KELLY
160x38	11.3081
160x57	11.3082
	27 cm



11.3075 60x20 mm

11.3072 35x7 mm

11.3073 35x10 mm

11.3074 35x15 mm

**LANGENBECK**  
 11.3072-11.3075  
 21 cm

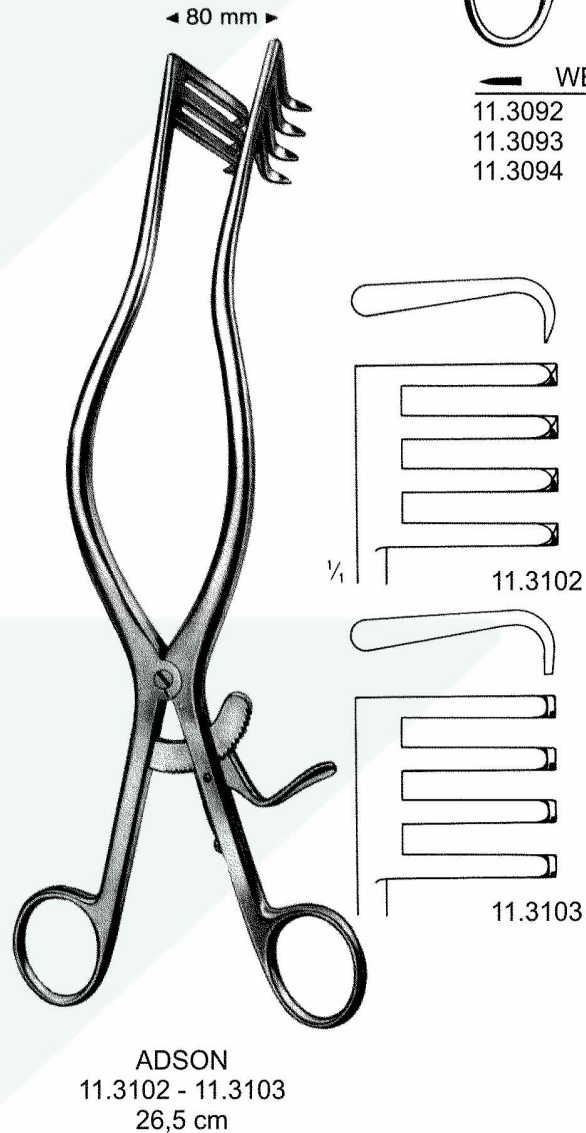
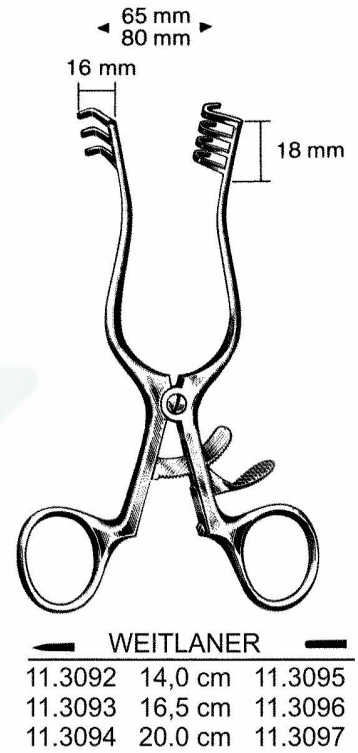
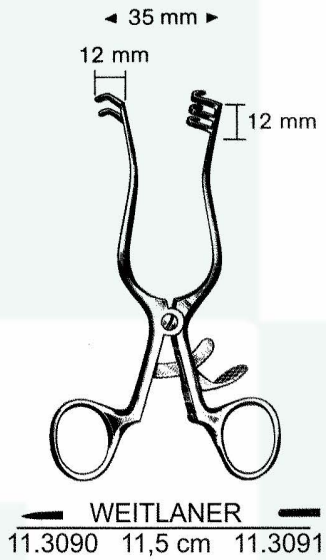

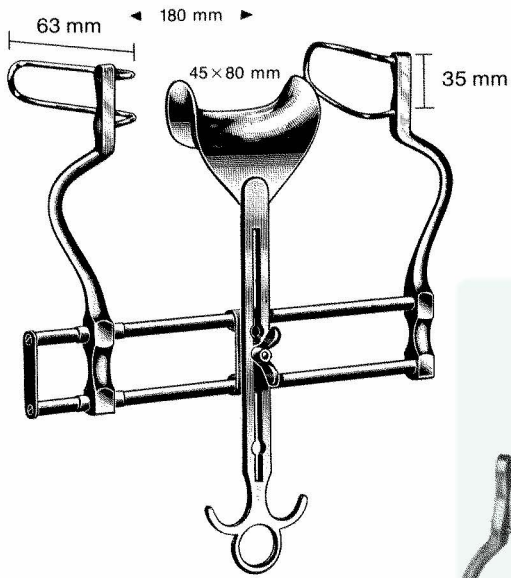

**BALFOUR**  
 11.3110  
 18 cm

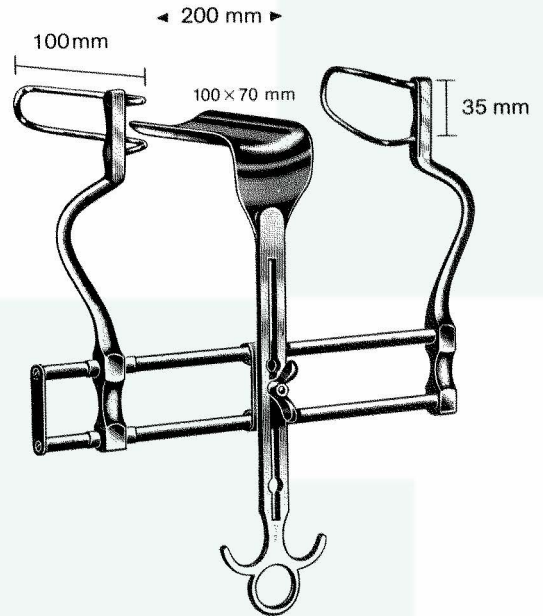

**BALFOUR**  
 11.3111  
 20 cm



**BALFOUR-BABY**  
 11.3112 95 mm

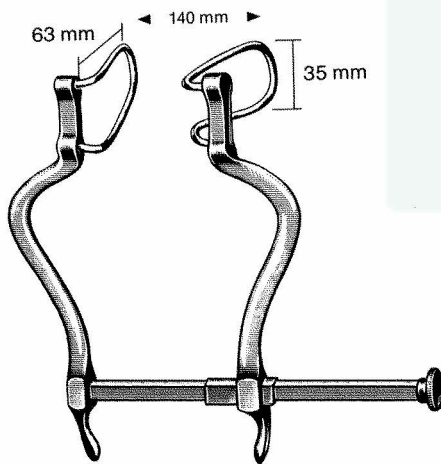

**GOSSET**  
 11.3120



**GOSSET**  
 11.3121



**CRILE**  
 11.3157 11.5 cm

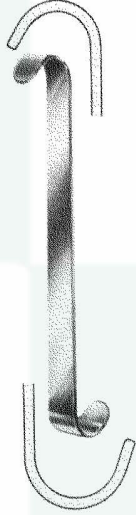

**LUER**  
 11.3158 12 cm

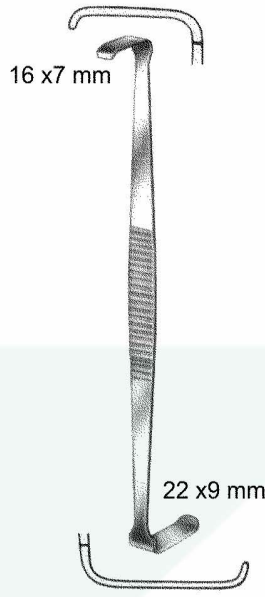

**HOUSE**  
 11.3159 15 cm



**SENN-GREEN**  
 11.3160 - 11.3161  
 15 cm



11.3160

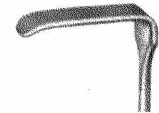

11.3161



**CUSHING**  
 11.3162  
 21 cm 10 x 11 mm

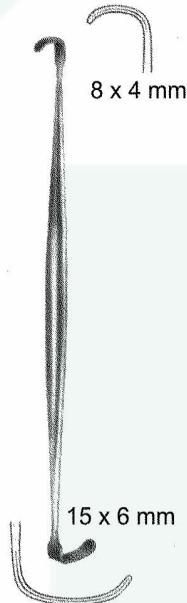

**RAGNELL**  
 11.3163 14 cm



**LANGENBECK-MINI**  
 11.3164 - 11.3167  
 16 cm



11.3164  
 10 x 6 mm

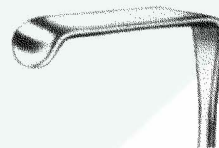

11.3166  
 20 x 5 mm



11.3165  
 17 x 5 mm

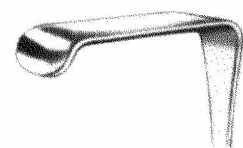

11.3167  
 22 x 5 mm



Wundhaken  
Retractors  
Ecarteurs  
Separadores  
Divaricatori

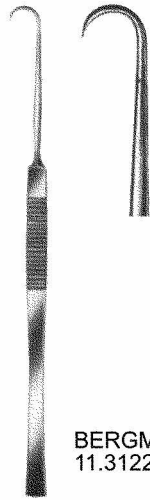

BERGMANN  
11.3122 14cm

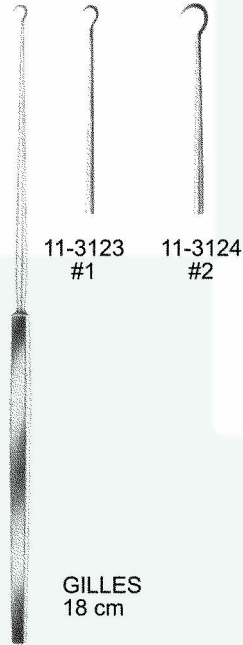

11-3123 #1  
11-3124 #2

GILLES  
18 cm

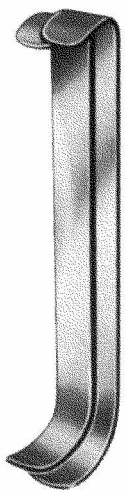

COLLIN  
11.3171 16 cm

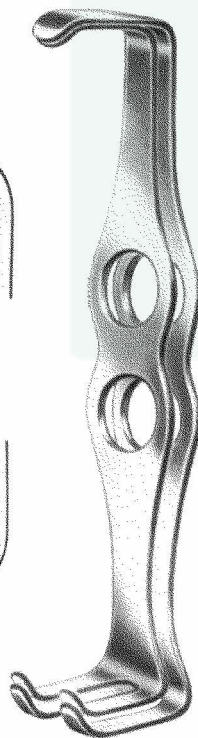
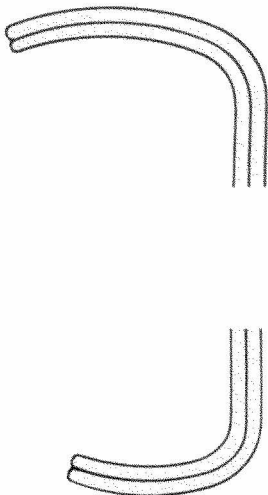

MATHIEU  
11.3175

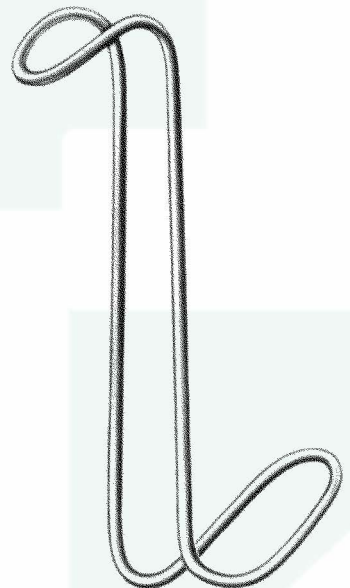

COLLIN-HARTMANN  
11.3176 16.5 cm

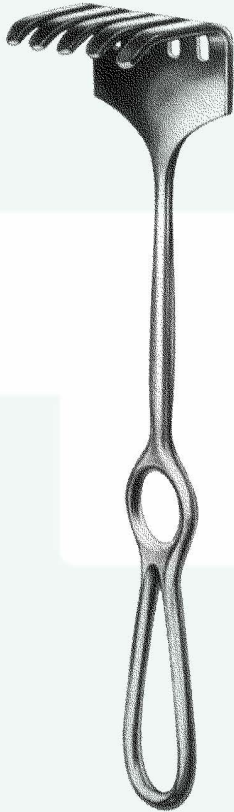

ISRAEL  
 11.3188  
 25 cm

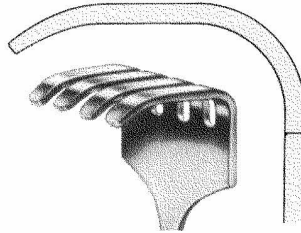

11.3189  
 40 x 40 mm

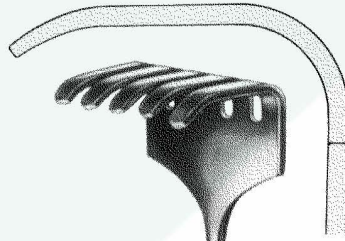

11.3190  
 45 x 45 mm

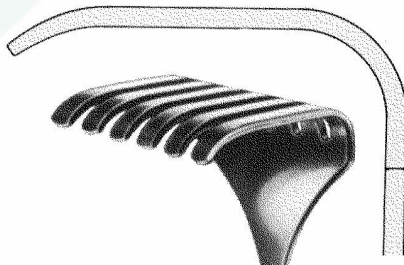

11.3191  
 50 x 60 mm

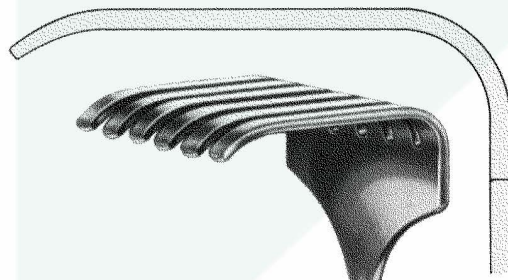

11.3192  
 70 x 70 mm

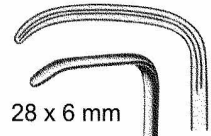

28 x 6 mm

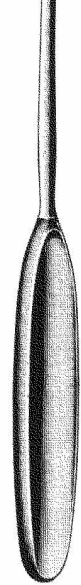

LAHEY  
 11.3193 19 cm

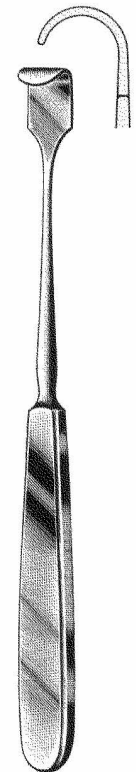

LITTLE  
 11.3194 20 cm

1

2

3

4

5

6

7

8

9

10

11

12

13

14

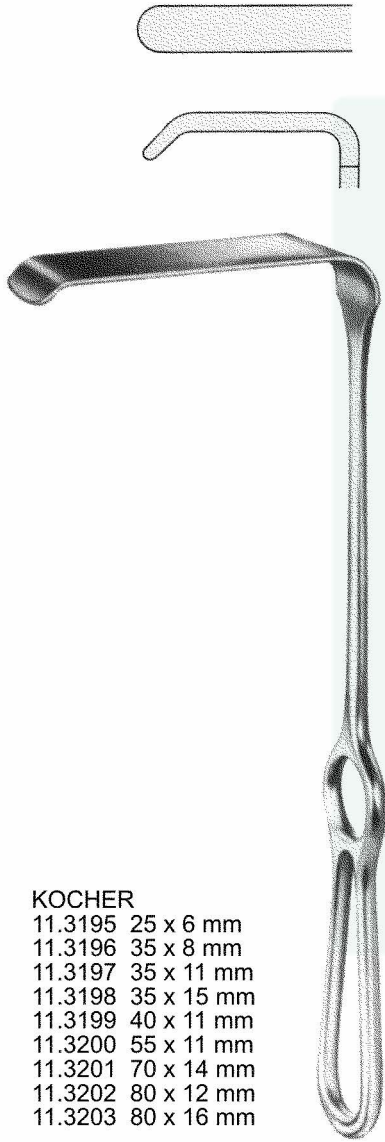

**KOCHER**  
 11.3195 25 x 6 mm  
 11.3196 35 x 8 mm  
 11.3197 35 x 11 mm  
 11.3198 35 x 15 mm  
 11.3199 40 x 11 mm  
 11.3200 55 x 11 mm  
 11.3201 70 x 14 mm  
 11.3202 80 x 12 mm  
 11.3203 80 x 16 mm

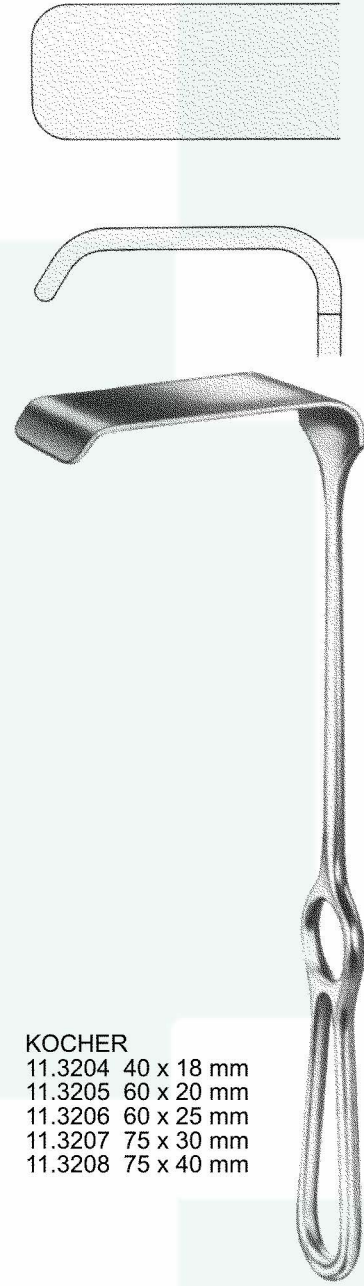

**KOCHER**  
 11.3204 40 x 18 mm  
 11.3205 60 x 20 mm  
 11.3206 60 x 25 mm  
 11.3207 75 x 30 mm  
 11.3208 75 x 40 mm

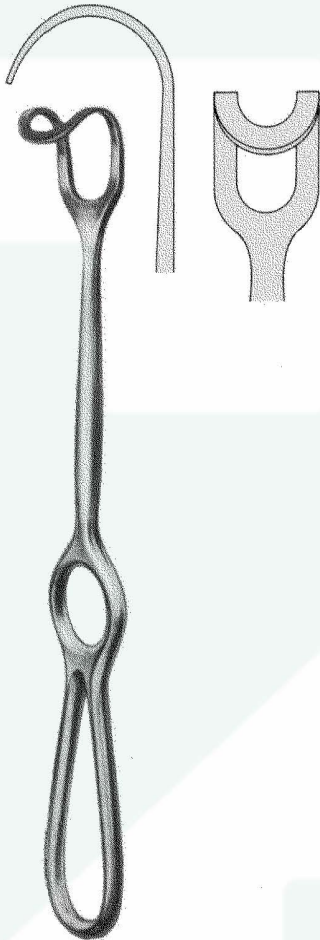

**MIDDELDORPF**  
 22 cm  
 11.3218 16 x 17 mm  
 11.3219 20 x 22 mm  
 11.3220 26 x 30 mm

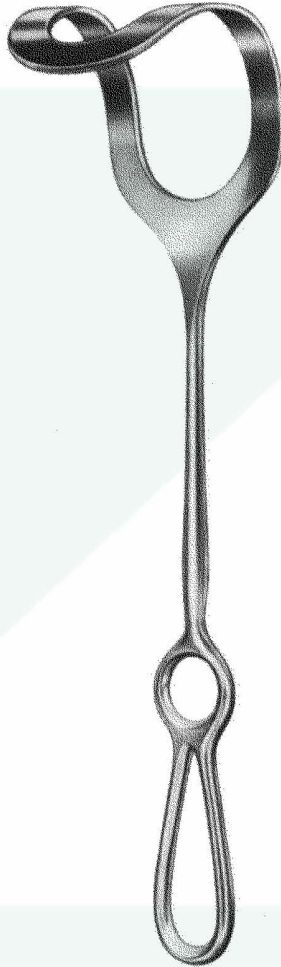

**MIDDELDORPF**  
 26 cm  
 11.3221 45 x 45 mm  
 11.3222 45 x 50 mm  
 11.3223 55 x 70 mm

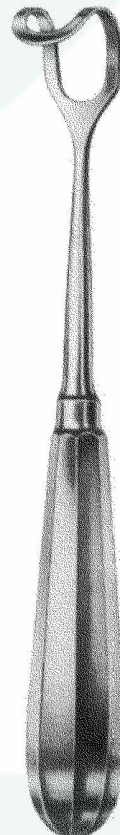

**MIDDELDORPF**  
 23 cm  
 11.3224 20 x 22 mm  
 11.3225 26 x 30 mm

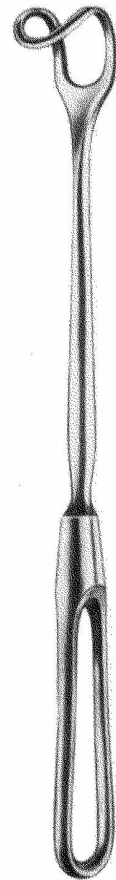

**GREEN**  
 11.3226 22 cm

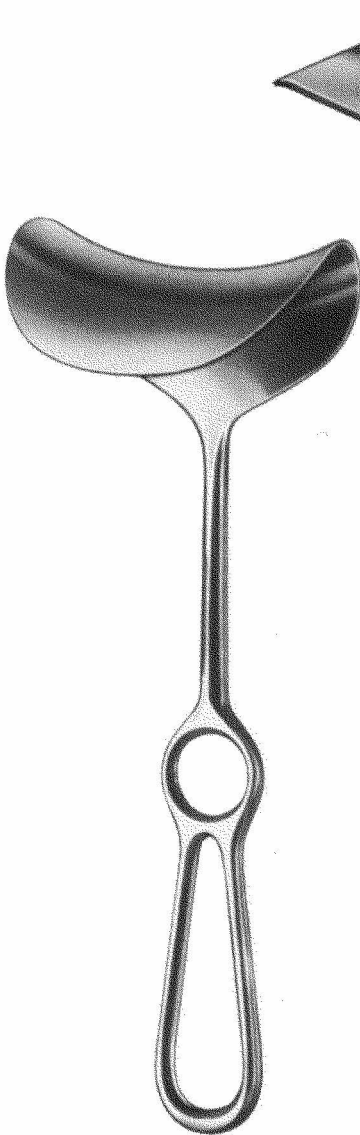

24 cm  
 11.3227 35 x 40 mm  
 11.3228 45 x 40 mm  
 11.3229 45 x 50 mm  
 11.3230 45 x 60 mm  
 11.3231 55 x 75 mm  
 11.3232 65 x 80 mm

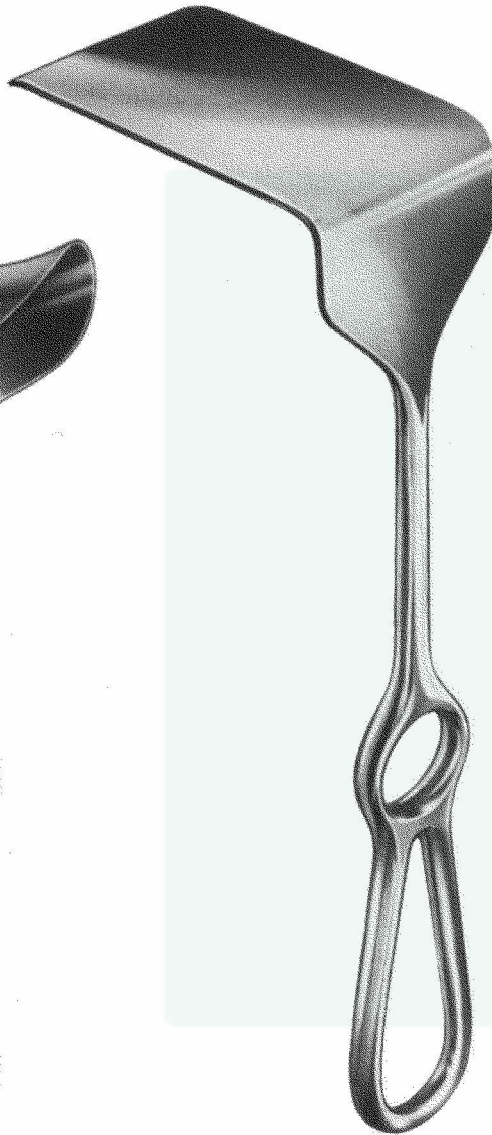

MIKULICZ  
 11.3242 24 cm  
 90 x 50 mm

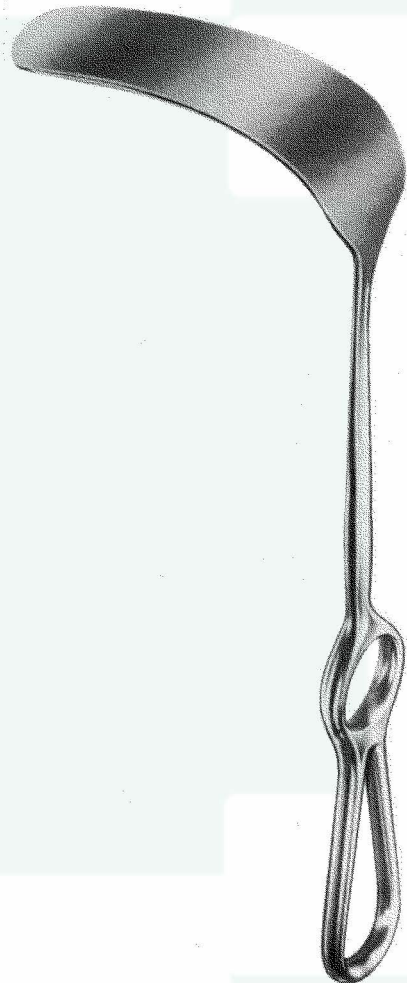

MIKULICZ  
 11.3243  
 95 x 35 mm



**BECKMANN**  
 11.3319 31 cm

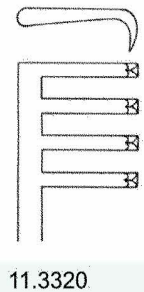
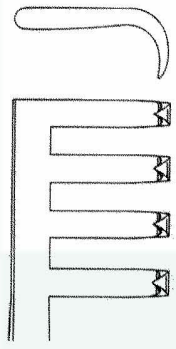

11.3320

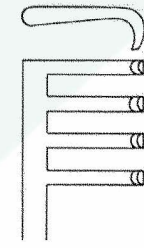

11.3321

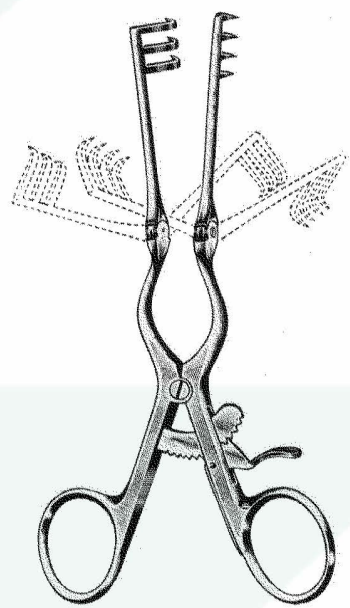

**ADSON-BABY**  
 16 cm

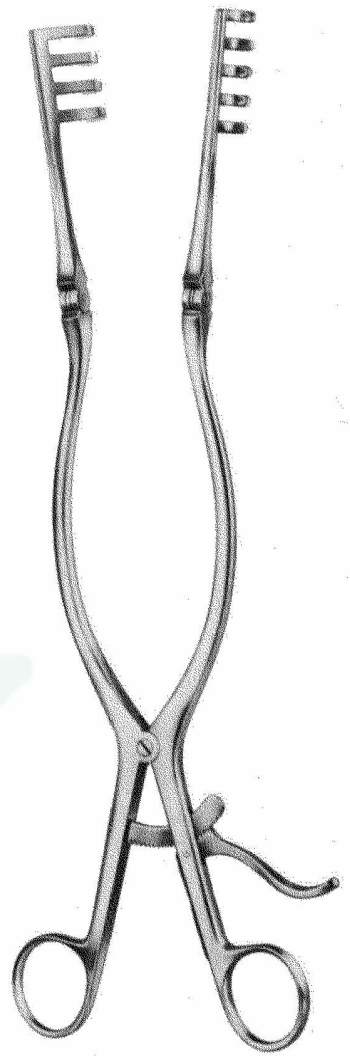
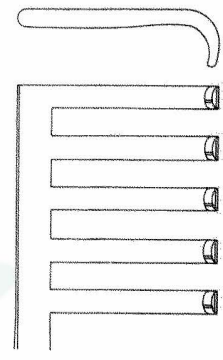

**ADSON**  
 11.3323 32 cm

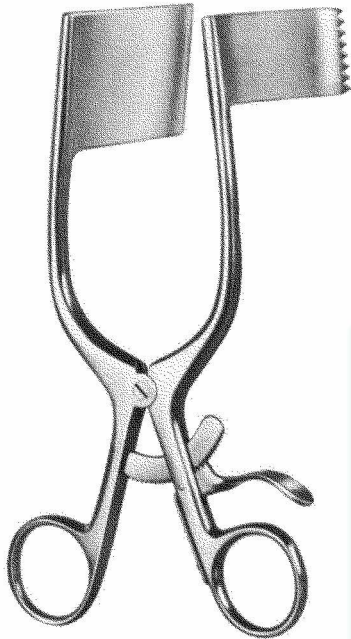

**DARLING**  
 11.3334 18 cm

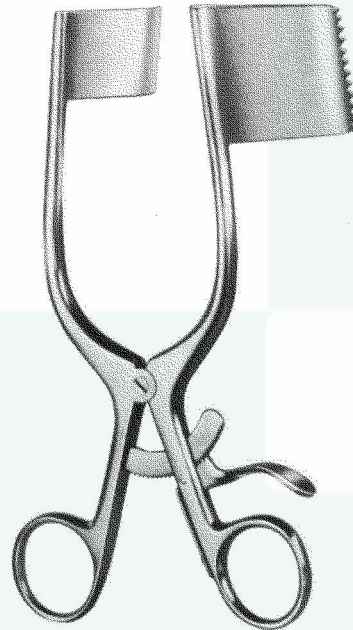

**DARLING**  
 11.3335 18 cm

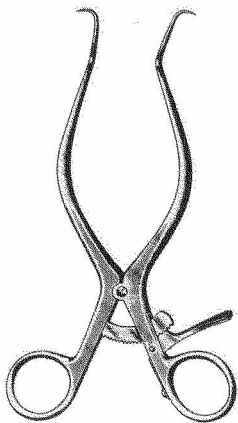

**GELPI-MINI**  
 11.3336 10 cm

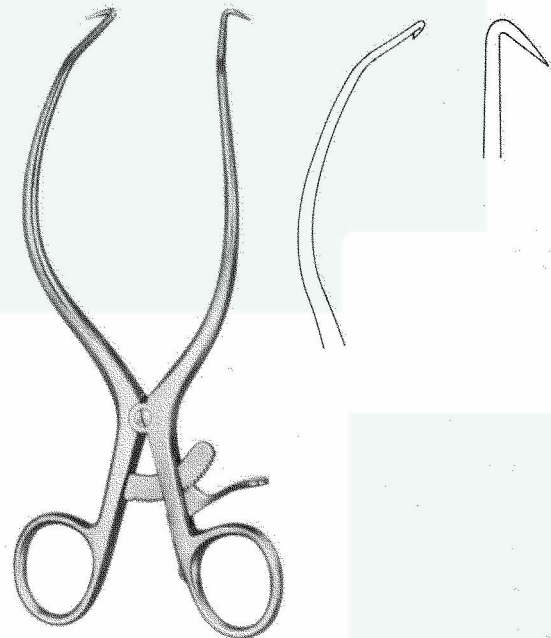

**GELPI-BABY**  
 11.3337 14 cm

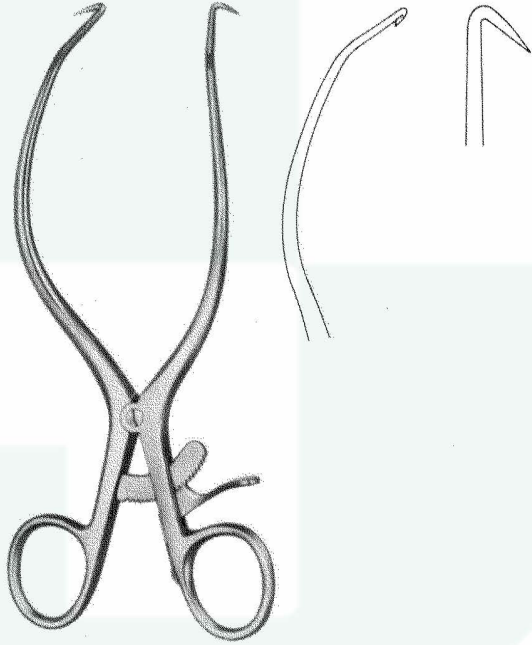

GELPI  
 11.3338 18 cm

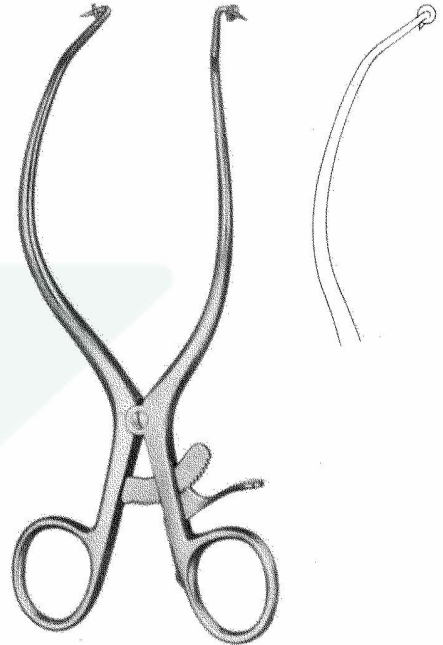

GELPI  
 11.3339 18 cm

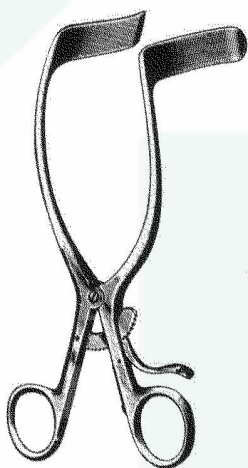

RIGBY  
 11.3342 18 cm  
 60 x 20 mm

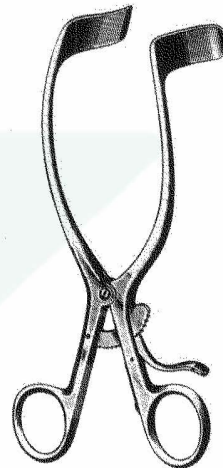

RIGBY  
 11.3343 18 cm  
 35 x 20 mm

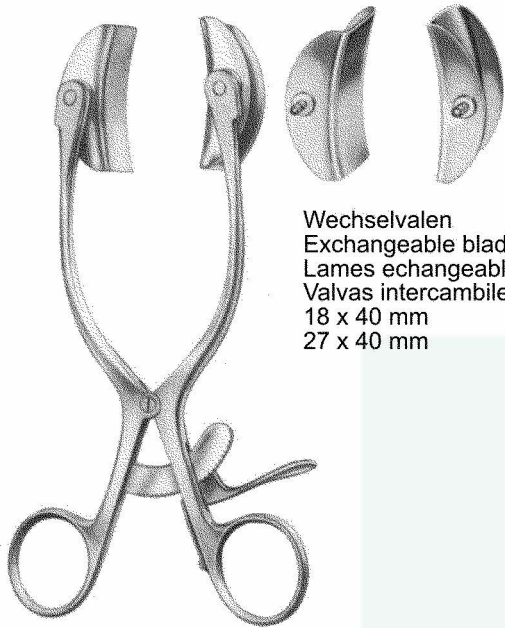

**COLLIN-BABY**  
 11.3350 18 cm

Wechselvalen  
 Exchangeable blades  
 Lames échangeables  
 Valvas intercambiles  
 18 x 40 mm  
 27 x 40 mm

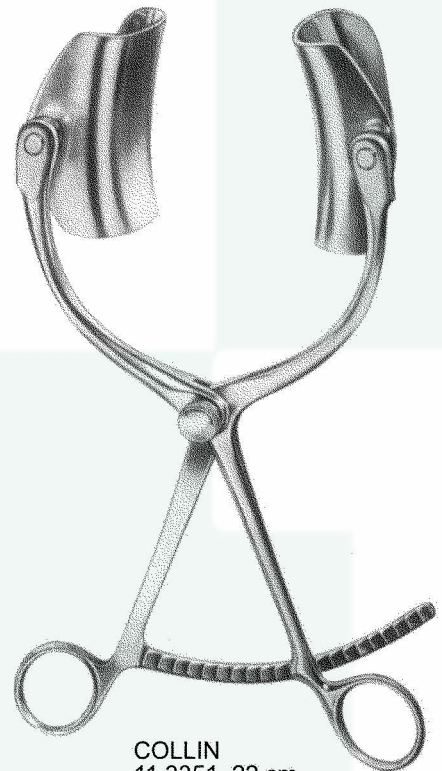

**COLLIN**  
 11.3351 22 cm  
 38 x 60 mm

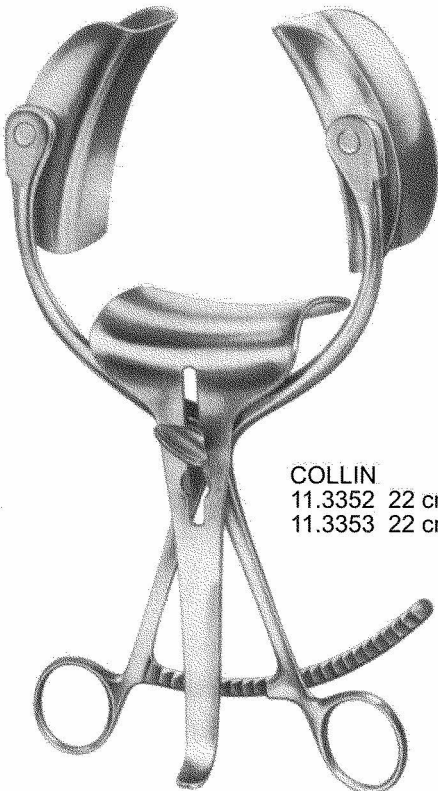

**COLLIN**  
 11.3352 22 cm 60 x 38 mm  
 11.3353 22 cm 60 x 80 mm

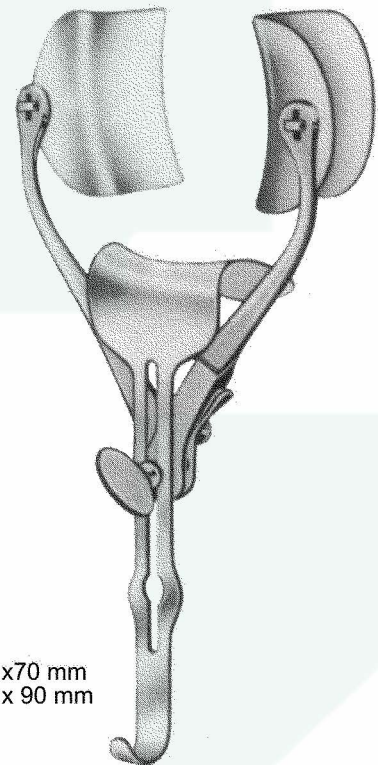

**RICARD**  
 11.3358 60 x 80 / 55 x 70 mm  
 11.3359 72 x 85 / 80 x 90 mm

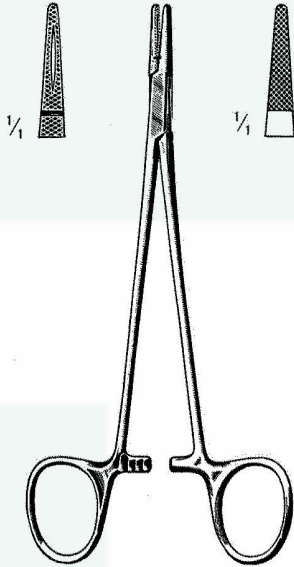

**CRILE WOOD**  
 11.4000 15 cm  
 11.4001 18 cm  
 11.4002 20 cm

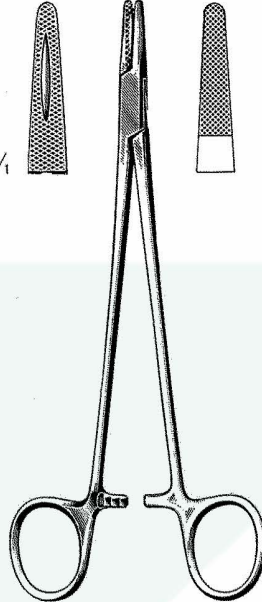

**MAYO HEGAR**  
 11.4003 14 cm  
 11.4004 16 cm  
 11.4005 18 cm  
 11.4006 20 cm  
 11.4007 24 cm  
 11.4008 26 cm  
 11.4009 30 cm

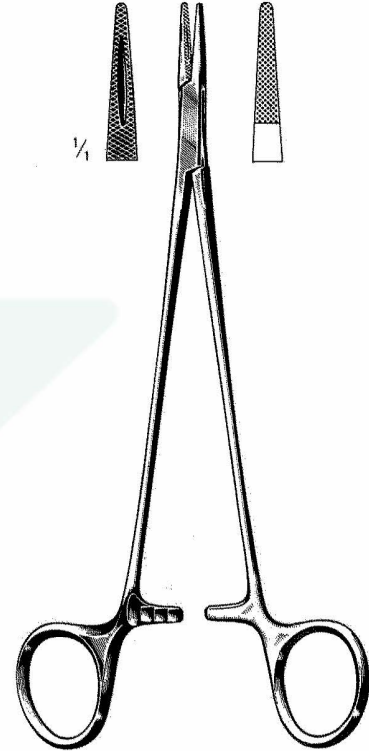

**MAYO HEGAR**  
 11.4010 16 cm  
 11.4011 18 cm  
 11.4012 20 cm

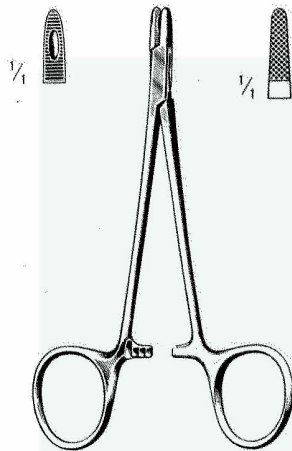

**DERF**  
 11.4013  
 12 cm

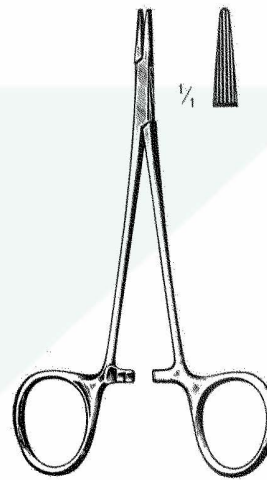

**DERF**  
 11.4014  
 12,5 cm

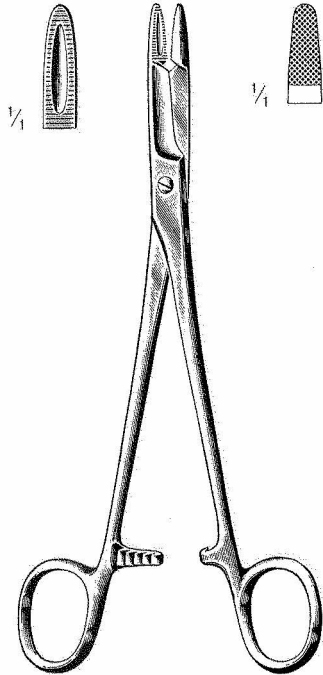

**OLSEN-HEGAR**  
 11.4020 14cm  
 11.4021 18 cm



**GILLIES**  
 11.4022 16cm

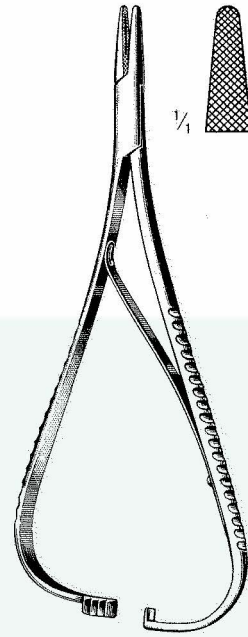

cm	MATHIEU
14	11.4023
17	11.4024
20	11.4025
24	11.4026

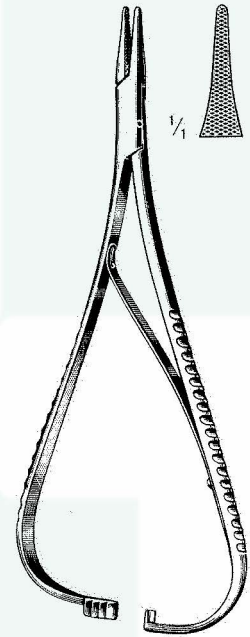

MATHIEU
11.4027
11.4028

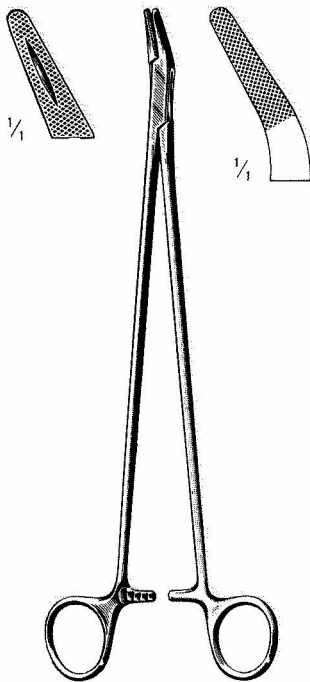

**FINOCHIETTO**  
 11.4029 20 cm  
 11.4030 27 cm

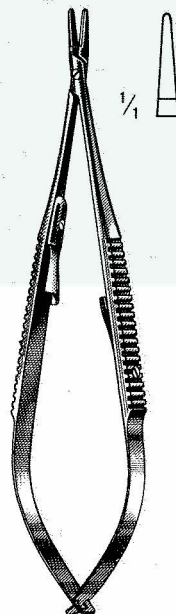

**CASTROVIEJO**  
 11.4031 14 cm 11.4032





**METZENBAUM**  
 11.3690 18 cm

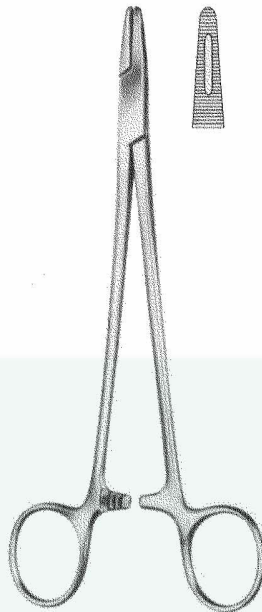

**ADSON**  
 11.3691 18 cm

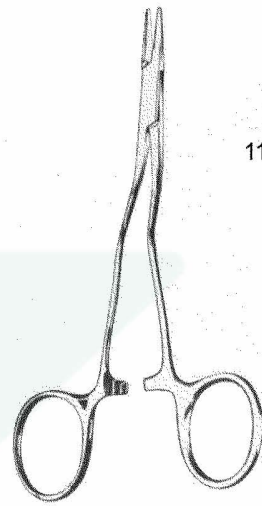

**KILNER**  
 13 cm

11.4017

11.4018  
 glatt  
 smooth  
 lisse  
 lisa  
 liscia

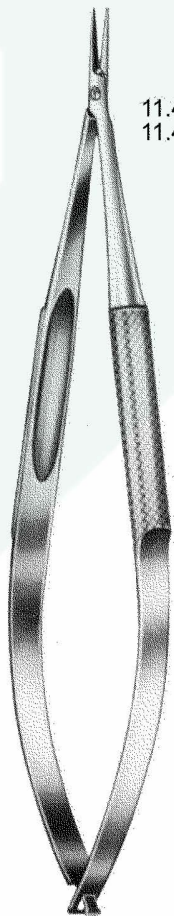

**MICRO**

11.4019 14 cm  
 11.4033 18 cm

11.4034 14 cm  
 11.4035 18 cm

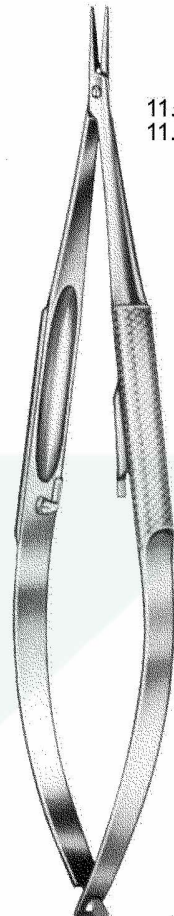

**MICRO**

11.4036 14 cm  
 11.4037 18 cm

11.4038 14 cm  
 11.4039 18 cm

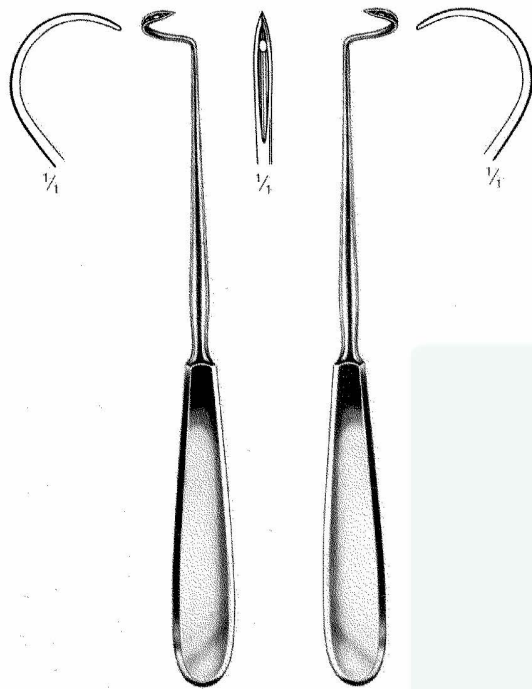

L	DESCHAMPS	R
11.4040	21 cm	11.4043
11.4041	24 cm	11.4044
11.4042	27 cm	11.4045

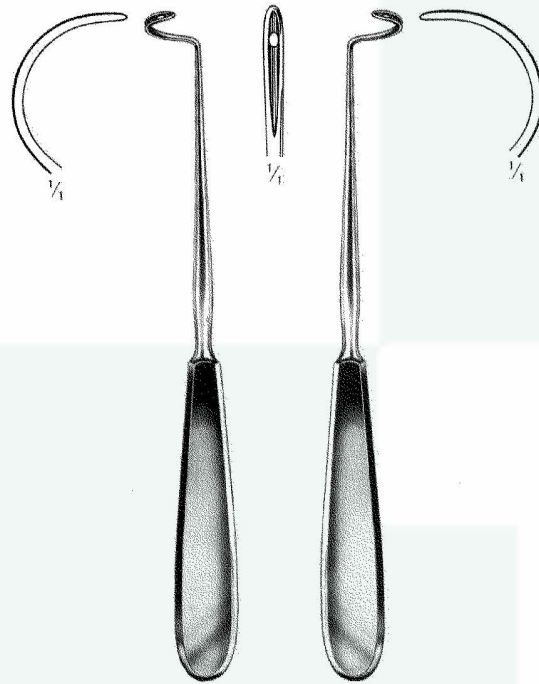

L	DESCHAMPS	R
11.4046	21 cm	11.4049
11.4047	24 cm	11.4050
11.4048	27 cm	11.4051

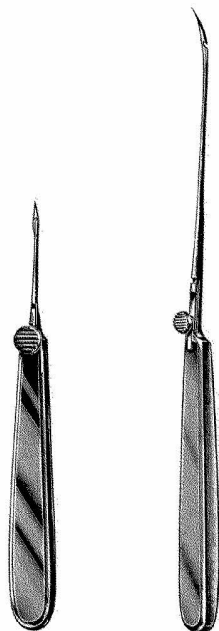

REVERDIN

cm15 cm19-23

cm

Fig. 1

Fig. 2

Fig. 3

Fig. 4

15	11.4060	11.4061	11.4062	11.4063
19	11.4064	11.4067	11.4070	11.4073
21	11.4065	11.4068	11.4071	11.4074
23	11.4066	11.4069	11.4072	11.4075

Trokare Sonden  
 Trocars-Probes, Directors  
 Trocars-Stylets, sondes  
 Trocares-Sondas, estiletos  
 Trequarti-Sonde, specilli

cm	2 mmØ	1 mmØ	2 mmØ		DOYEN		STACKE
10,5							
11,5	11.4080	11.4090	11.4100		11.4120		11.4150
13,0	11.4081	11.4091	11.4101		11.4121		
14,0						11.4130	
14,5	11.4082	11.4092	11.4102	11.4110	11.4122		11.4140
16,0	11.4083	11.4093	11.4103		11.4123		
18,0	11.4084	11.4094	11.4104		11.4124		
20,0	11.4085	11.4095	11.4105		11.4125		
25,0	11.4086	11.4096	11.4106		11.4126		

mm	UNIVERSAL	STANDARD	STANDARD	PIERCE
3,0		11.4161	11.4168	11.4175
3,5		11.4162	11.4169	
4,0		11.4163	11.4170	11.4176
4,5		11.4164	11.4171	
5,0		11.4165	11.4172	11.4177
5,5		11.4166	11.4173	
6,0		11.4167	11.4174	

Universal  
11.4160  
set of 4 pcs.  
compl.

Trokare Sonden  
 Trocars-Probes, Directors  
 Trocars-Stylets, sondes  
 Trocares-Sondas, estiletes  
 Trequarti-Sonde, specilli

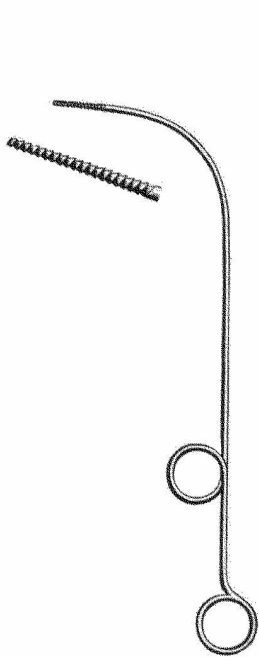

PELTERSON  
 11.4178 23 cm

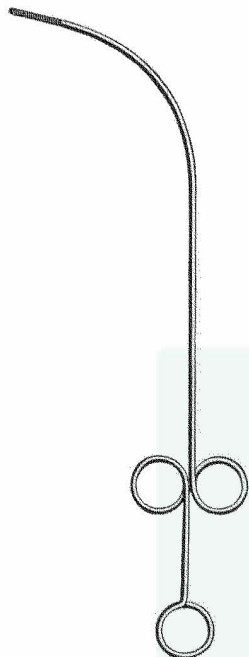

PELTERSON  
 11.4179 28 cm

- 11.4180 12 cm
- 11.4181 14 cm
- 11.4182 16 cm
- 11.4183 18 cm
- 11.4184 23 cm

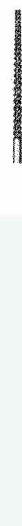

FARRELL



- 11.4185 12 cm
- 11.4186 14 cm
- 11.4187 16 cm
- 11.4188 18 cm
- 11.4189 23 cm

FARRELL

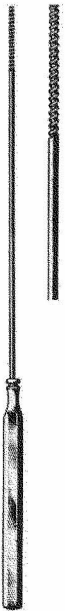

Martin

- 11.4190 12 cm
- 11.4191 14 cm
- 11.4192 16 cm
- 11.4193 18 cm



- 11.4194 12 cm
- 11.4195 14 cm
- 11.4196 16 cm
- 11.4197 18 cm



UCKERMANN  
 11.4198

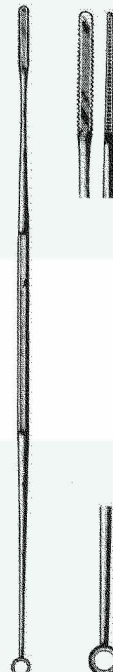

JOBSON-HORNE  
 11.4199 14.5 cm  
 11.4200 18 cm

Hakenzangen  
 Tenaculum Forceps  
 Pincés pour abaissement du col de l' utérus  
 Pinzas para coger el cuello del útero  
 Pinze per abbassare il collo dell' utero

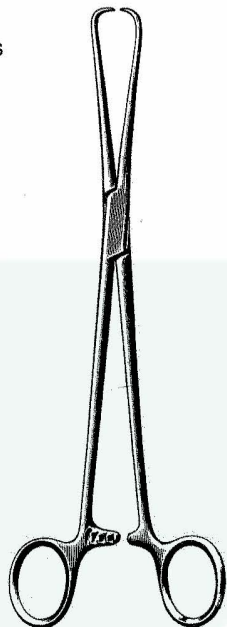

**SCHROEDER-POZZI**  
 11.5000  
 25 cm

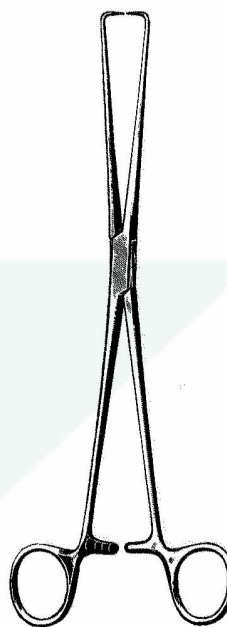

**BRAUN**  
 11.5001  
 25 cm

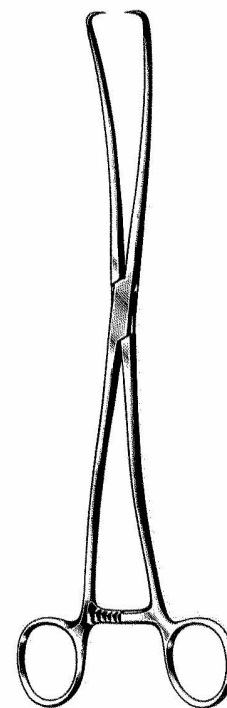

**DUPLAY**  
 11.5002  
 28 cm

Hakenzangen  
 Vulsellum Forceps  
 Pincés pour abaissement du col de l' utérus  
 Pinzas para coger el cuello del útero  
 Pinze per abbassare il collo dell' utero

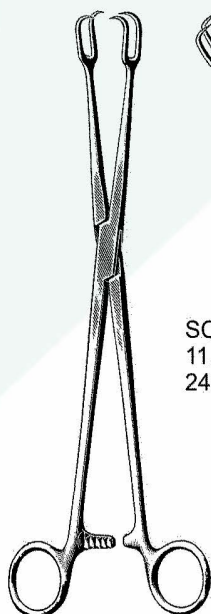

**SCHROEDER**  
 11.5004  
 24 cm

**SCHROEDER**  
 11.5003  
 24 cm

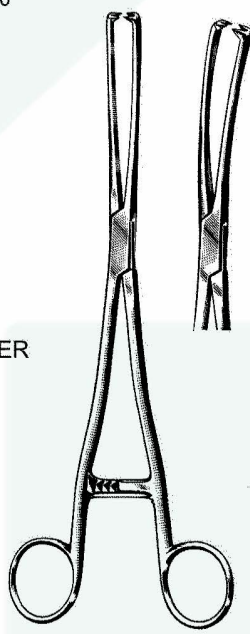

MUSEUX		
11.5005	6mm	11.5008
11.5006	8mm	11.5009
11.5007	10mm	11.5010
24 cm		

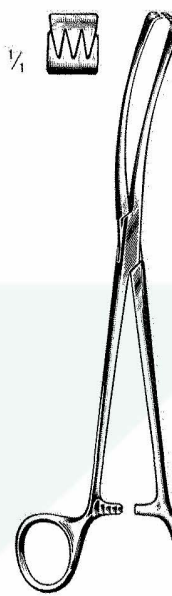
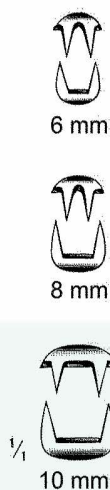

**TEALE**  
 11.5011  
 23 cm

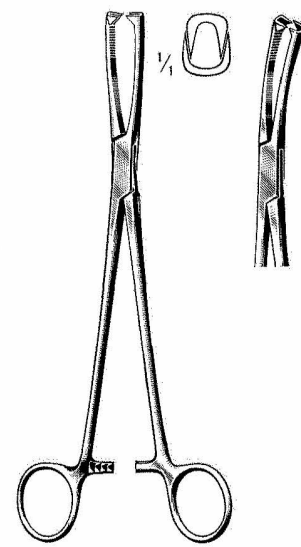

**JACOBS**  
 11.5012 21 cm 11.5013

Uterus-polypenzangen  
 Uterine Polypus Forceps  
 Pincés à polypes utérins  
 Pinzas para pólipos uterinos  
 Pinze per polipi uterini

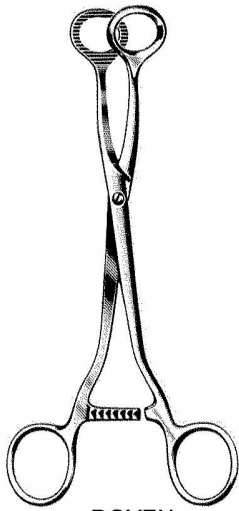

DOYEN  
 11.5020  
 20 cm

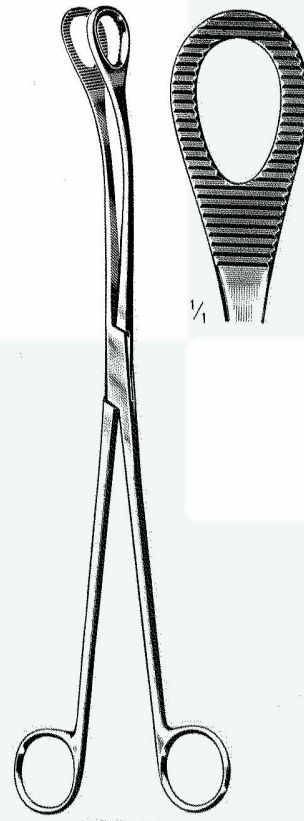

KELLY  
 11.5021  
 32 cm

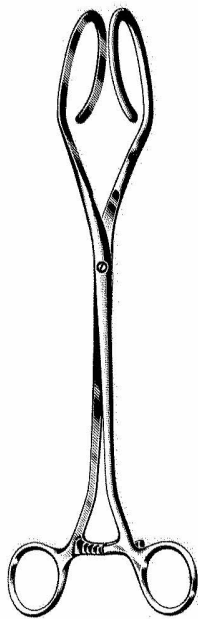

DARTIGUES  
 11.5022  
 27 cm

Uterus-Faßzangen  
 Uterine Elevating Forceps  
 Pincés hystérolabes  
 Pinzas para el útero  
 Pinze per afferrare l'utero

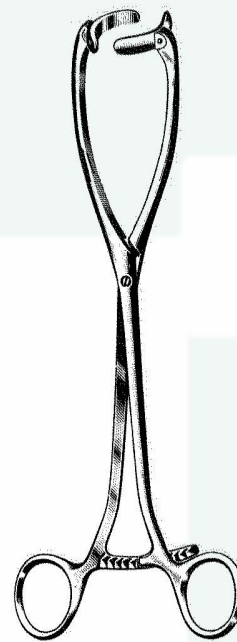

COLLIN  
 11.5023  
 25 cm

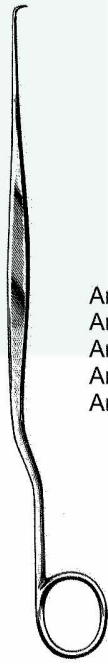

Amniotom  
 Amniotome  
 Amniotome  
 Amniótomo  
 Amniotomo

BEACHAM  
 11.5030  
 26 cm



Uterus-Depressoren  
 Uterine Depressors  
 Dépresseurs utérins  
 Depresores uterinos  
 Depressori uterini

BRAUN  
 11.5031  
 28 cm

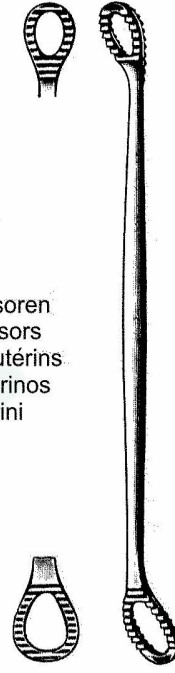

SIMS  
 11.5032  
 26 cm

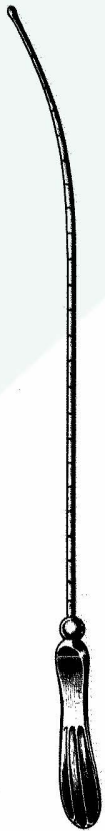

Uterus-Sonden  
 Uterine Sounds  
 Hystéromètres  
 Histerómetros  
 Isterometri

starr  
 rigid  
 rigide  
 rigida  
 rigia

11.5033 32 cm

biegsam  
 malleable  
 malleable  
 maleable  
 malleabile

11.5034



starr  
 rigid  
 rigide  
 rigida  
 rigia

11.5035 32 cm

biegsam  
 malleable  
 malleable  
 maleable  
 malleabile

11.5036

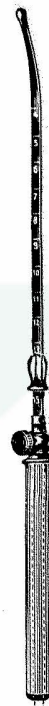

COLLIN  
 11.5037  
 28 cm



Valleix  
 11.5038  
 30 cm

11.5038.10 25 cm  
 11.5038.20 33 cm

Uterus-Biopsie-Saugküretten  
Uterine Biopsy Aspirating Curettes  
Curettes aspirantes à biopsie de l'utérus  
Curetas aspiradoras p. la biopsia uterina  
Curette di aspirazione per biopsia



RANDALL  
11.5040  
24 cm/4 mm

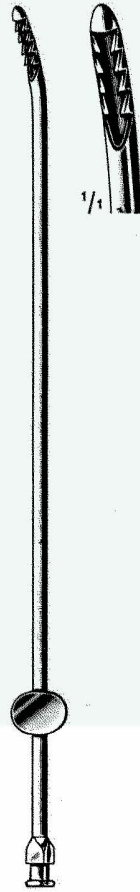

mm	NOVAK
1	11.5041
2	11.5042
3	11.5043
4	11.5044

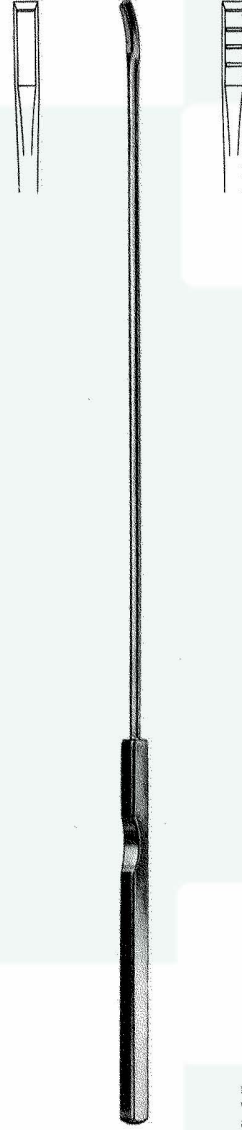

KEVORKIAN		
11.5045	1,2 mm	
11.5046	4,0 mm	11.5047
30 cm		

mit Korb  
with basket  
avec grille  
con cesto  
con cestino

Probeexcisionszangen  
 Biopsy Specimen Forceps  
 Pinces emporte-pièce pour le col de l'utérus  
 Pinzas sacabocado para el cuello del útero  
 Pinze taglianti per biopsia



**FAURE**  
 11.5050  
 21 cm

cm	SCHUBERT
21	11.5051
28	11.5052

**SCHUBERT**  
 11.5053  
 26 cm

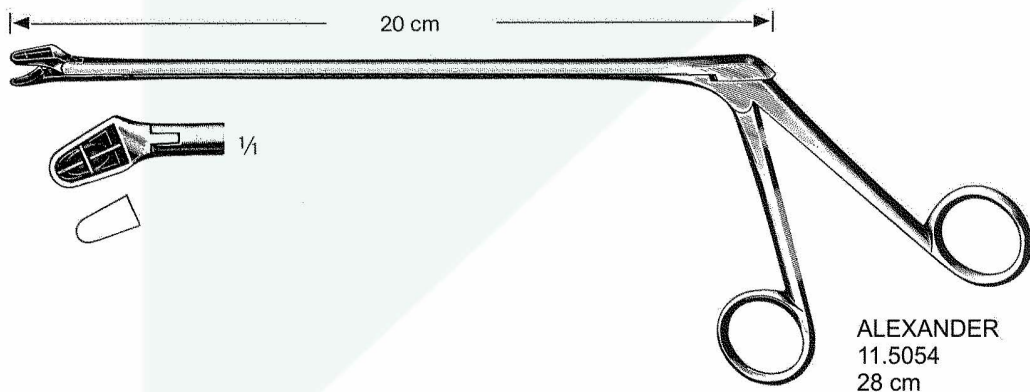

**ALEXANDER**  
 11.5054  
 28 cm

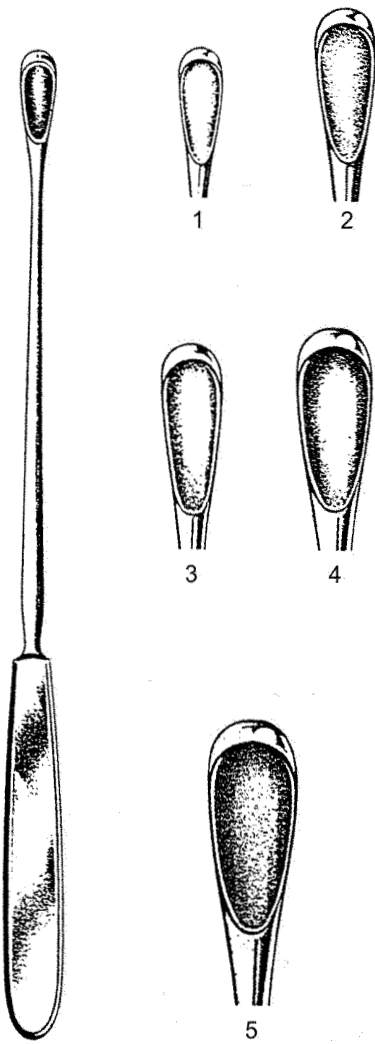

Fig. GOURDET

1	11.5060	11.5060
2	11.5061	11.5061
3	11.5062	11.5062
4	11.5063	11.5063
5	11.5064	11.5064
28 cm		

scharf  
 sharp  
 tranchant  
 cortante  
 tagliente

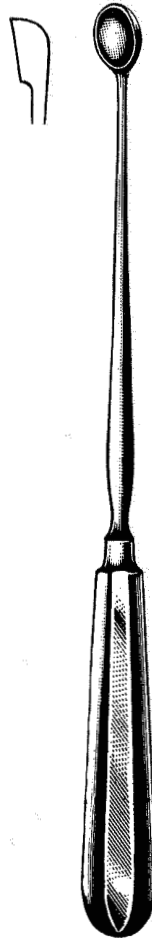

Fig.	SIMON	
1	11.5070	11.5070
2	11.5071	11.5071
3	11.5072	11.5072
4	11.5073	11.5073
5	11.5074	11.5074
6	11.5075	11.5075
25 cm		



Uteruslöffel, -kürette  
 Uterine Curettes  
 Curettes utérines  
 Curetas uterinas  
 Curette uterine



2



3



4



5



6

scharf/stumpf  
 sharp/blunt  
 tranchant/mousse  
 cortante/roma  
 tagliente/smussa

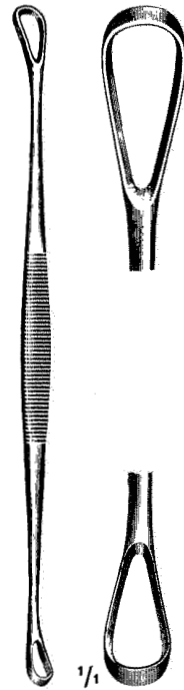

BLAKE  
 11.5080  
 27 cm  
 11.5080

Uterus-Küretten  
 Uterine Curettes  
 Curettes Utérines  
 Curetas uterinas  
 Curette uterine

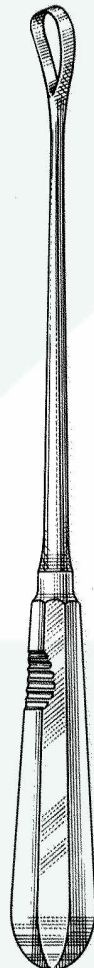
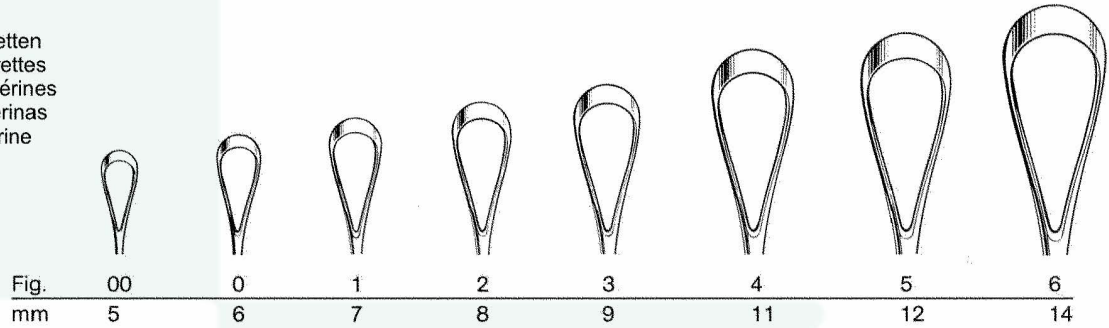

scharf	stumpf
sharp	blunt
tranch.	mousse
cort.	roma
tagl.	smussa
A	B

Fig.	A	B
00	11.5090	11.5100
0	11.5091	11.5101
1	11.5092	11.5102
2	11.5093	11.5103
3	11.5094	11.5104
4	11.5095	11.5105
5	11.5096	11.5106
6	11.5097	11.5107

SIMS  
 11.5090-11.5107  
 28 cm

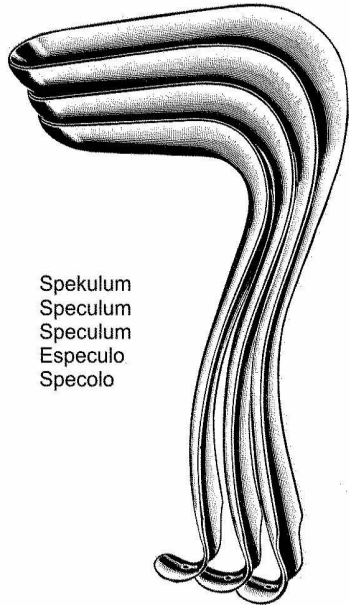

Spekulum  
 Speculum  
 Speculum  
 Especulo  
 Specolo

KRISTELLER Fig. mm		
11.5110	1	70 x 27
11.5111	2	80 x 30
11.5112	3	90 x 36

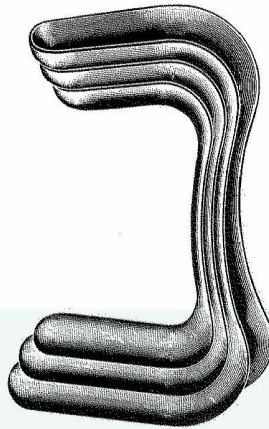

SIMS Fig. mm.		
11.5120	1	60x25/30
11.5121	2	70x30/35
11.5122	3	80x35/40
11.5123 = Set		

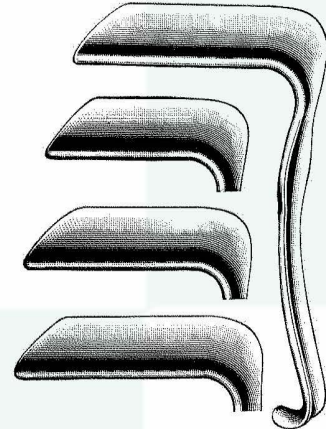

JACKSON Fig. mm		
11.5130	1	75 x 38
11.5131	2	90 x 38
11.5132	3	100 x 38

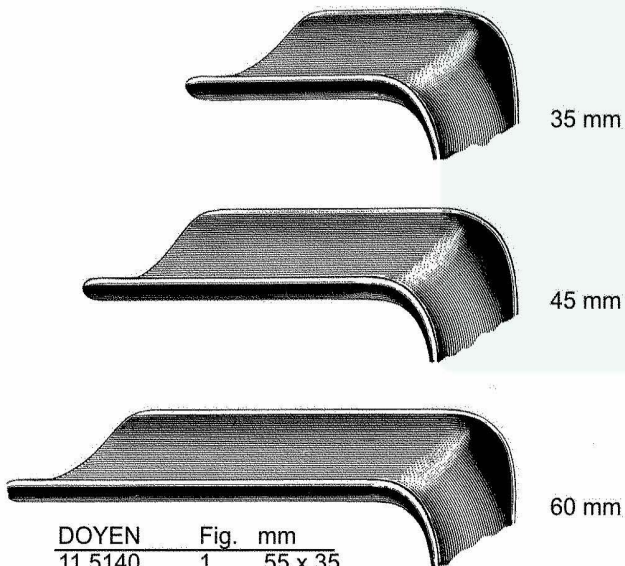

DOYEN Fig. mm		
11.5140	1	55 x 35
11.5141	2	85 x 35
11.5142	3	115 x 35
11.5143	1	55 x 45
11.5144	2	85 x 45
11.5145	3	115 x 45
11.5146	4	160 x 45
11.5147	1	55 x 60
11.5148	2	85 x 60

DOYEN Fig. mm		
11.5149	3	115 x 60
11.5150	4	160 x 60

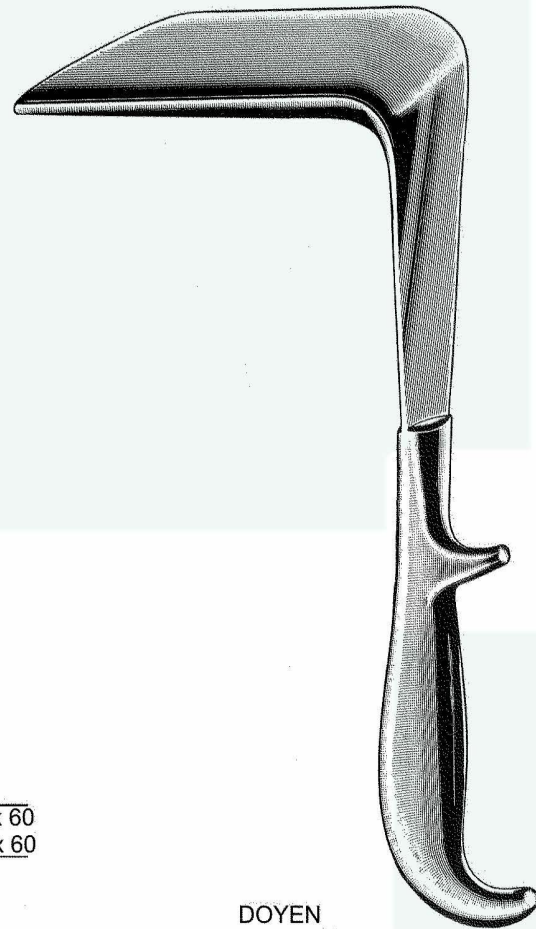

DOYEN  
 11.5140-11.5150

Scheidenspekula  
 Vaginal Specula  
 Secula Vaginaux  
 Especuid ios Vaginaes  
 Specula Vabinali



AUVARD  
 11.5151  
 65 x 38 - 28mm  
 1.530 kg = 3 lbs. 6 oz.  
 Mit abnehmbaren Gewicht  
 with detachable weight  
 230 mm, 9"

AUVARD  
 11.5152R 75 x 42 - 40 mm  
 11.5153R 105 x 43 - 40 mm  
 1.470 kg = 3 lbs. 4 oz.  
 Mit abnehmbaren Gewicht  
 with detachable weight  
 230 mm, 9"

1

2

3

4

5

6

7

8

9

10

11

12

13

14

Vaginal-Spekula  
Vaginal Specula  
Spéculums vaginaux  
Espéculos vaginales  
Specoli vaginali



GRAVE

Fig.	mm	Standard
1	75 x 20	08.692
2	95 x 35	08.693
3	115 x 35	08.694



PEDERSON	Fig.	mm
08.695	1	75 x 13
08.696	2	100 x 22
08.697	3	120 x 25

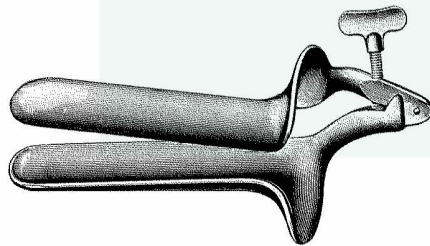

COLLIN	Fig.	mm
08.689	1	85 x 30
08.690	2	100 x 35
08.691	3	110 x 40
08.689/v	4	Virgo

Vaginal-Spekula  
 Vaginal Specula  
 Spéculums vaginaux  
 Espéculos vaginales  
 Specoli vaginali

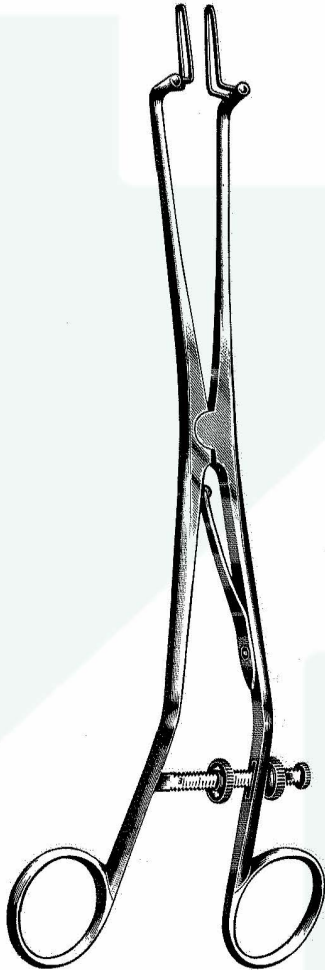

KOGAN  
 11.5160  
 24 cm



Seittl. Schraube  
 Lateral Screw  
 Vis latérale  
 Tornillo lateral  
 Vite laterale

CUSCO	Fig.	mm
08.681	1	75x32
08.682	2	85x35
08.683	3	100x35
08.684	4	virgo

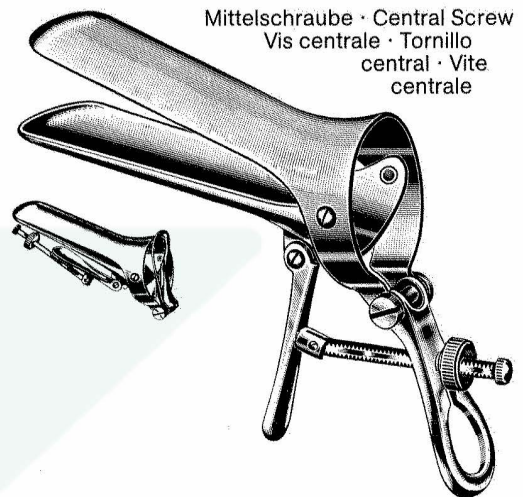

Mittelschraube · Central Screw  
 Vis centrale · Tornillo  
 central · Vite  
 centrale

CUSCO	Fig.	mm
08.685	1	75x32
08.686	2	85x36
08.687	3	95x37
08.688	4	virgo

Uterus-Dilatatoren  
 Uterine Dilators  
 Dilatateurs uterins  
 Dilatadores uterinos  
 Dilatatori uterini



HEGAR



HEGAR  
 11.5235  
 4-17 mm  
 14 Stück/ea./pces./c./u./pezzi

mm	HEGAR		mm
1	11.5170	11.5200	1,5
2	11.5171	11.5201	2,5
3	11.5172	11.5202	3,5
4	11.5173	11.5203	4,5
5	11.5174	11.5204	5,5
6	11.5175	11.5205	6,5
7	11.5176	11.5206	7,5
8	11.5177	11.5207	8,5
9	11.5178	11.5208	9,5
10	11.5179	11.5209	10,5
11	11.5180	11.5210	11,5
12	11.5181	11.5211	12,5
13	11.5182	11.5212	13,5
14	11.5183	11.5213	14,5
15	11.5184	11.5214	15,5
16	11.5185	11.5215	16,5
17	11.5186		
18	11.5187		
19	11.5188		
20	11.5189		
21	11.5190		
22	11.5191		
23	11.5192		
24	11.5193		
25	11.5194		
26	11.5195		
27	11.5196		
28	11.5197		
29	11.5198		
30	11.5199		

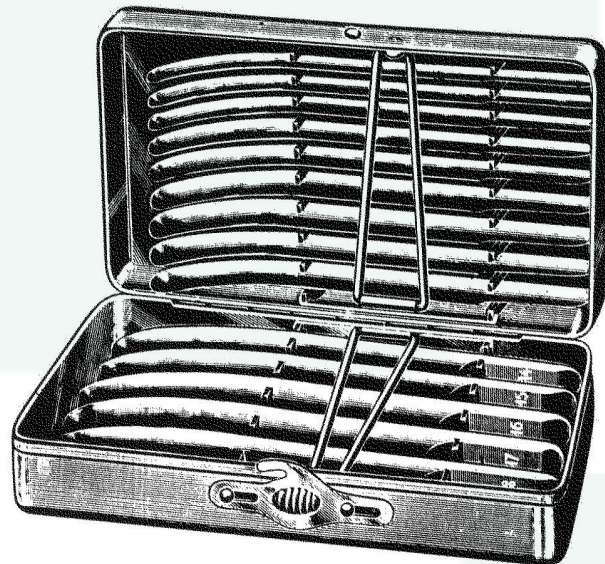

11.5230 Satz/Set/Jeu/Juego  
 11.5173-11.5186=14

11.5231 Satz/Set/Jeu/Juego  
 11.5170-11.5195=26

Uterus-Dilatatoren  
 Uterine Dilators  
 Dilatateurs uterins  
 Dilatadores uterinos  
 Dilatatori uterini

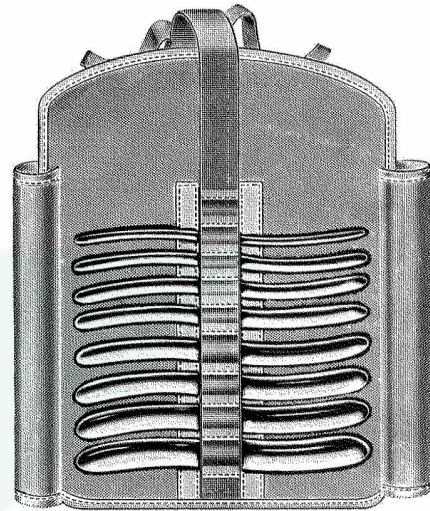
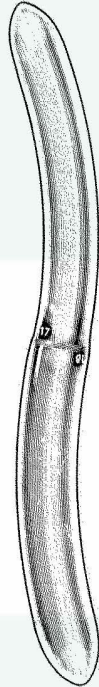

HEGAR  
 11.5258  
 3/4-17/18 mm  
 8 Stuck/ea./pces./c./u./pezzi

cm	HEGAR
1/ 2	11.5240
3/ 4	11.5241
5/ 6	11.5242
7/ 8	11.5243
9/ 10	11.5244
11/12	11.5245
13/14	11.5246
15/16	11.5247
17/18	11.5248
19/20	11.5249
21/22	11.5250
23/24	11.5251
25/26	11.5252

→ 11.5255 Satz/Set/Jeu/Juego  
 11.5241-11.5248 = 8  
 11.5256 Satz/Set/Jeu/Juego  
 11.5240-11.5252 = 13

mm	HANK	U.S.
4,5/ 5	11.5260	9/10
4,5/ 6	11.5261	11/12
4,5/ 7	11.5262	13/14
4,5/ 8	11.5263	15/16
4,5/ 9	11.5264	17/18
4,5/ 10	11.5265	19/20
	11.5270	
	Set/6	

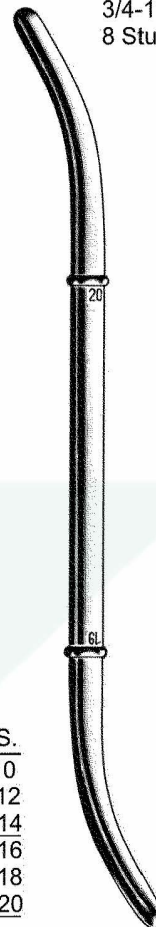

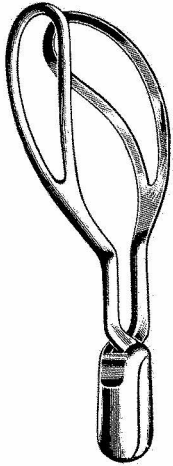

**WRIGLEY**  
 11.5280  
 23 cm

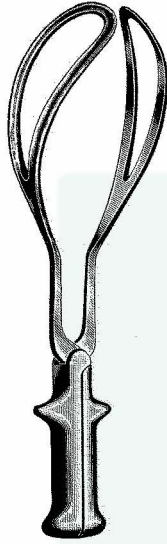

**SIMPSON**  
 11.5281  
 30 cm

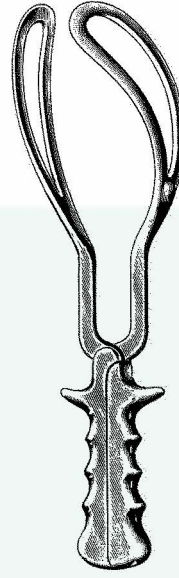

cm	SIMPSON-BRAUN
33	11.5282
36	11.5283

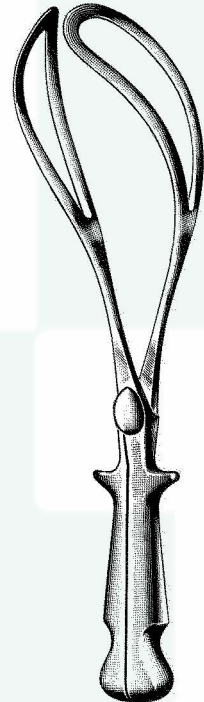

cm	NAEGELE
36	11.5284
40	11.5285

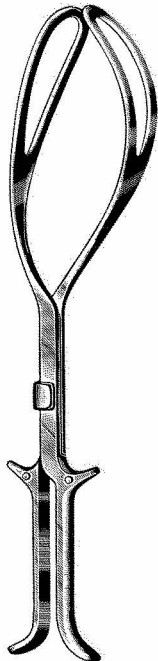

**KIELLAND**  
 11.5286  
 41 cm

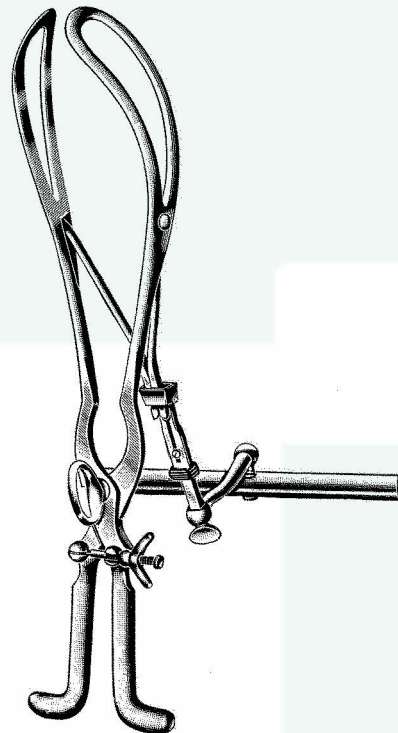

**TARNIER**  
 11.5287  
 40 cm

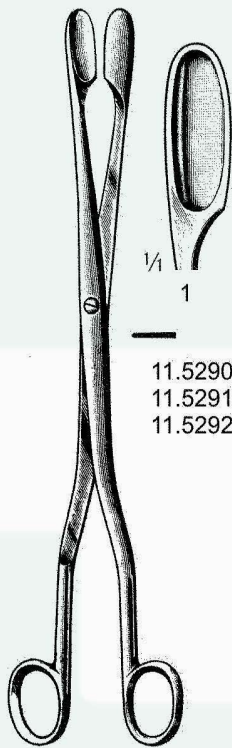

**WINTER**  
 11.5290-11.5295  
 28 cm

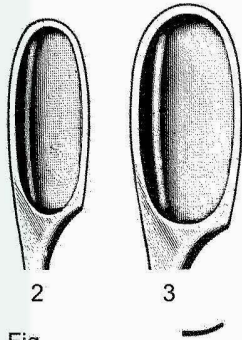
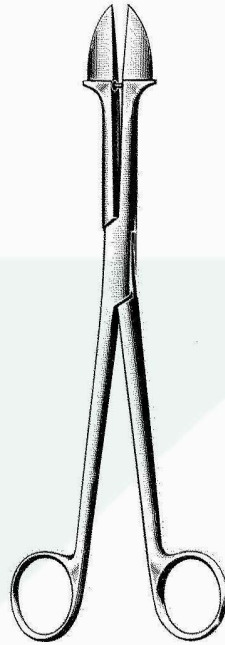

Fig.  
 1 11.5293  
 2 11.5294  
 3 11.5295



**SMELLIE**  
 11.5300  
 25 cm



**SMELLIE**  
 11.5301  
 33 cm

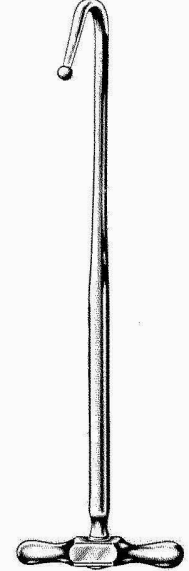

**BRAUN**  
 11.5302  
 30 cm

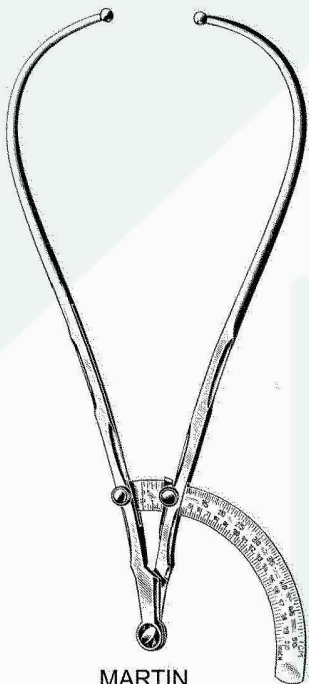

**MARTIN**  
 11.5310  
 34 cm

11.5310  
 11.5311  
 11.5320  
 11.9999

Beckenzirkel  
 Pelvimeters  
 Compas pelvimètres  
 Pelvimetros  
 Pelvimetri

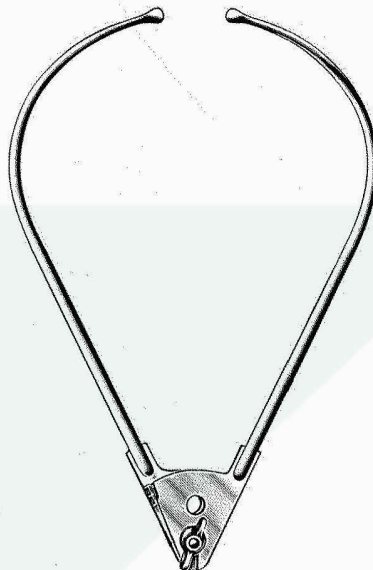

**COLLYER**  
 11.5311  
 30 cm

Nabelschnurklemmen  
 Umbilical Cord Clamps  
 Clamps p. cordon ombilical  
 Clamps umbilicales  
 Pinze ombelicali

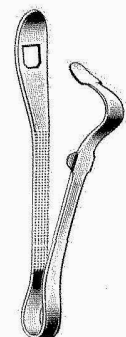

**COLLIN**  
 11.5320  
 9 cm

Biopsiezangen  
 Biopsy Speciman Forceps  
 Pincès à biopsie  
 Pinzas sacabocado p. biopsia  
 Pinze per biopsia

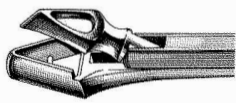

24 cm

< 11.5330  
 < 11.5331

SCHUMACHER  
 11.5330-11.5331  
 24 cm

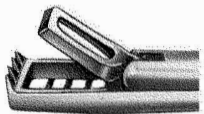
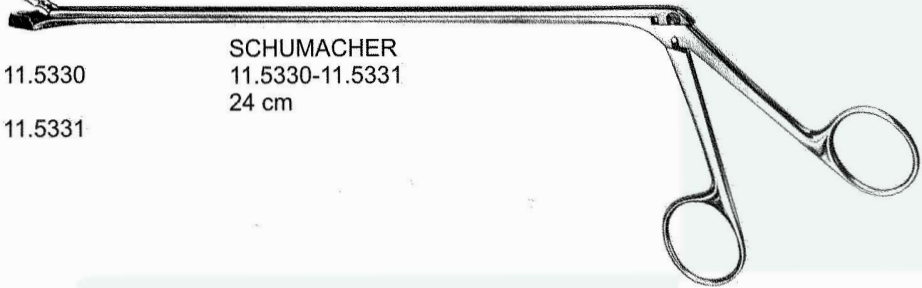

3X9.7 mm

KEVORKIAN  
 11.5335  
 24,5 cm

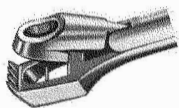
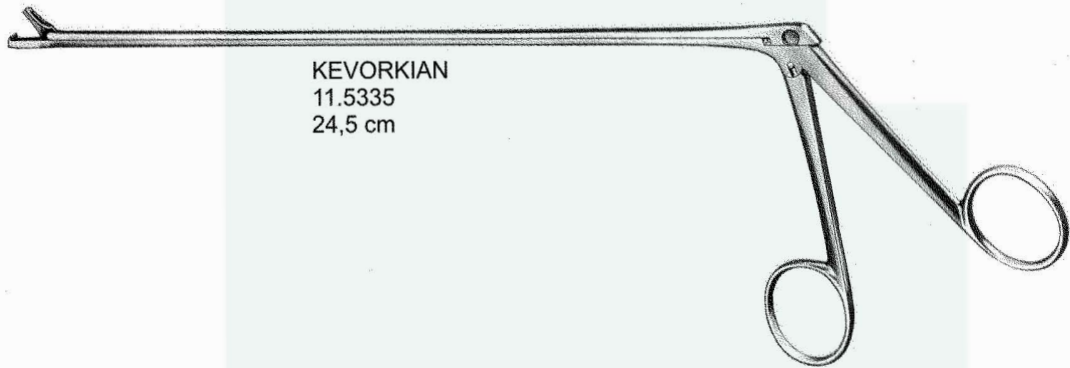

4x8 mm

WITTNER		
11.5340	23 cm	11.5341

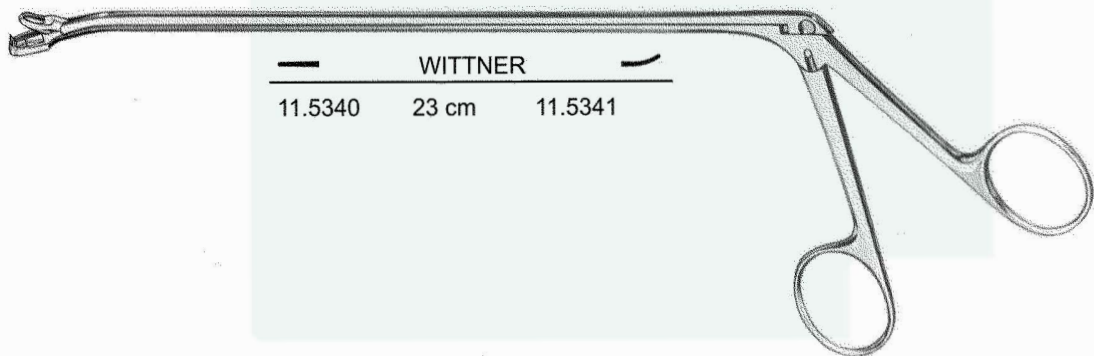

3x7 mm

TISCHLER-MORGAN  
 11.5345

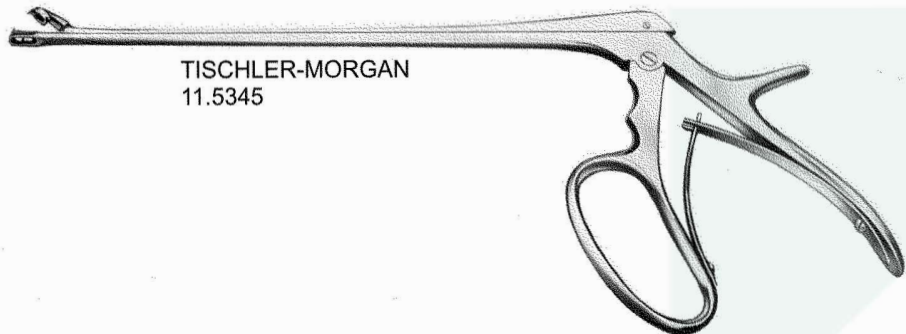

Ohr-Spekula  
 Ear Specula  
 Spéculum auriculaires  
 Espéculos auriculares  
 Specoli auricolari

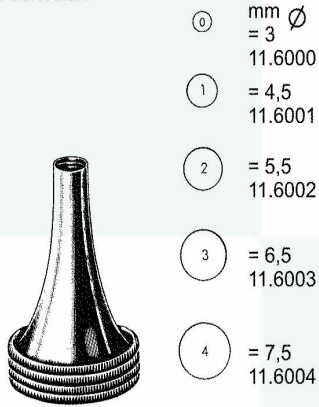

**HARTMANN**  
 11.6005  
 Set = 4

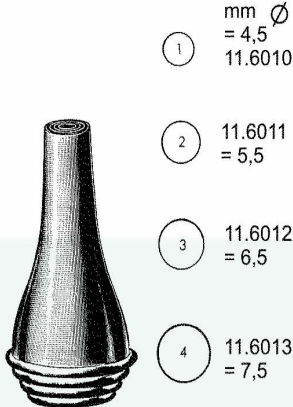

**GRUBER**  
 11.6015  
 Set = 4

Schlingen, Häkchen, Pinzetten  
 Loops, Hooklets, Dressing Forceps  
 Anses, Crochets, Pinzas  
 Asas, Ganchitos, Pinzas  
 Anse, Uncinetti, Pinze

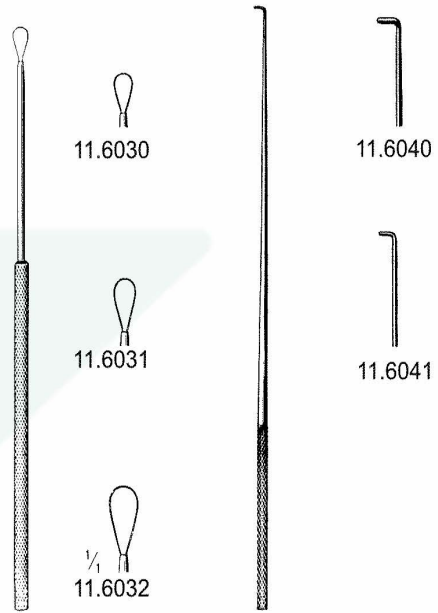

**BILLEAU**  
 11.6030 - 11.6032

**DAY**  
 11.6040 - 11.6041

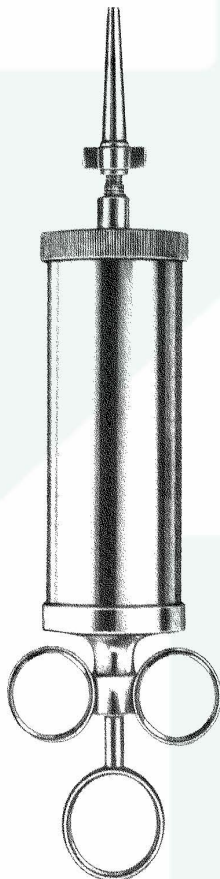

**REINER**

ml	
50	11.6020
75	11.6021
100	11.6022
150	11.6023



**LUCAE**  
 11.6050  
 14 cm



**LUCAE**  
 11.6051  
 16 cm

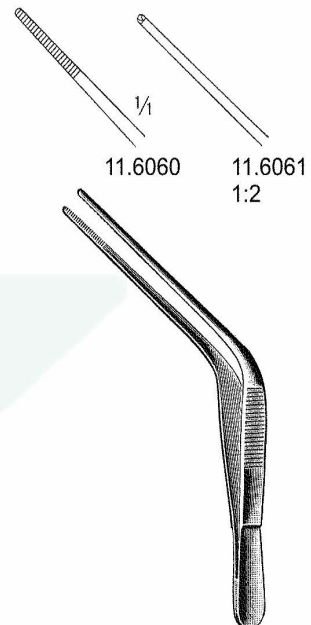

**WILDE (TROELTSCH)**  
 11.6060-11.6061  
 12 cm

Ohrzängchen  
 Ear Forceps  
 Pincés auriculaires  
 Pinzas auriculares  
 Pinze auricolari

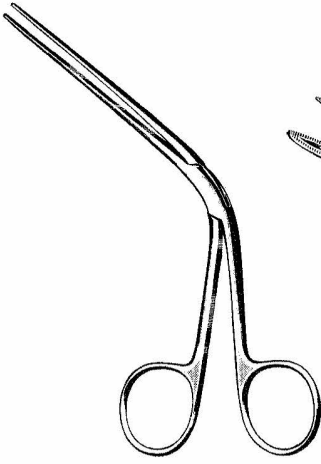

**TILLEY**  
 11.6070  
 14 cm



**LITTAUER**  
 11.6071  
 12 cm

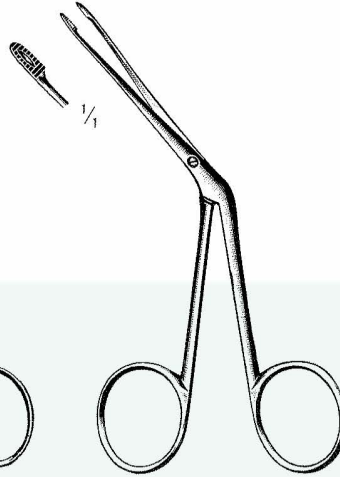

**HARTMANN**  
 11.6072  
 12 cm

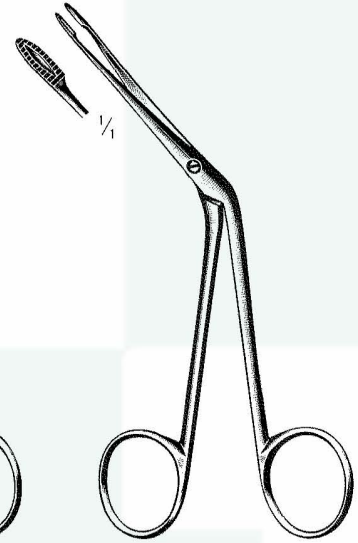

**HARTMANN**  
 11.6073  
 14 cm

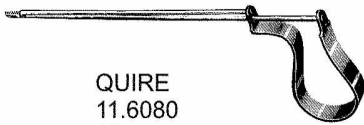

**QUIRE**  
 11.6080  
 10 cm

Fremdkörperhebel  
 Foreign Body Levers  
 Leviers pour corps étrangers  
 Elevadores para cuerpos extranjerros  
 Leve per corpi estranei

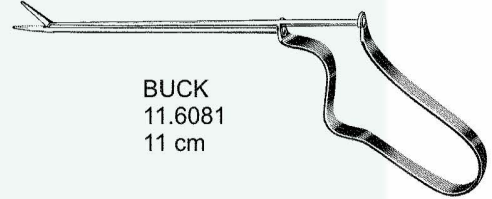

**BUCK**  
 11.6081  
 11 cm

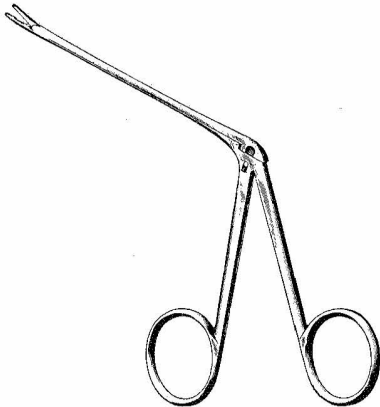

11.6090-11.6113



**HARTMANN-WULLSTEIN**  
 11.6090  
 8,5 cm



**HARTMANN-WULLSTEIN**  
 11.6091  
 8,5 cm



cm	HARTMANN
8,5	11.6092
14,0	11.6093
16,0	11.6094



cm	HARTMANN
8,5	11.6100
14,0	11.6101



**HARTMANN**  
 11.6102  
 8,5 cm



Ømm	HARTMANN
2,0	11.6103
2,5	11.6104
3,0	11.6105
8,5 cm	

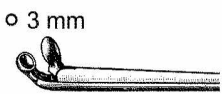

**HARTMANN**  
 11.6110  
 8,5 cm



**STRUEMPEL**  
 11.6111  
 8,5 cm



**HARTMANN**  
 11.6112  
 8,5 cm

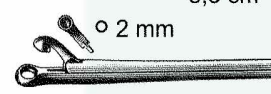

**HARTMANN-HOFFMANN**  
 11.6113  
 8,5 cm

Miko-Ohrzängchen  
 Micro Ear Forceps  
 Pincès auriculaires micro  
 Pinzas auriculares micro  
 Pinze auricolari micro



11.6120 - 11.6127



11.6120  
4 mm



11.6121  
7 mm



11.6122  
4 mm



11.6123  
6 mm



11.6124  
6 mm



11.6125  
4 mm



11.6126  
4 mm



11.6127  
3,5 mm

Mikro-Ohrscherchen  
 Micro Ear Scissors  
 Ciseaux auriculaires micro  
 Tijeras auriculares micro  
 Forbici auricolari micro



11.6130 - 11.6137



BELLUCCI  
11.6130  
MICRO MINI  
4 mm



BELLUCCI  
11.6131  
MICRO STANDARD  
5,5 mm



BELLUCCI  
11.6132  
MICRO STANDARD  
5,5 mm



BELLUCCI  
11.6133  
MICRO STANDARD  
5,5 mm



BELLUCCI  
11.6134  
MICRO STANDARD  
5,5 mm



SHEA  
11.6135  
7,0 mm



SHEA  
11.6136  
7,0 mm

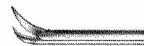

SHEA  
11.6137  
7,0 mm

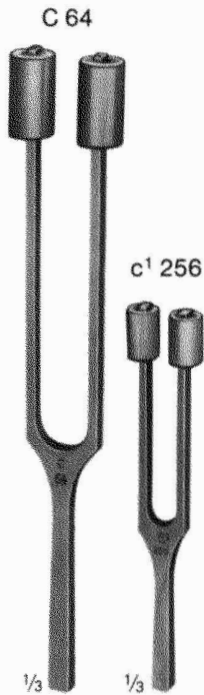

FRENCH/HARTMAN

French		aus Aluminium of aluminium en aluminium de aluminio in alluminio
C <sub>2</sub> 16	11.6140	
C <sub>1</sub> 32	11.6141	
Hartman		
c 64	11.6142	
c 128	11.6143	11.6145
c¹ 256	11.6144	11.6146



HARTMAN

		Aluminium
c 128	11.6147	
c¹ 256	11.6148	11.6153
c² 512	11.6149	11.6154
c³ 1024	11.6150	11.6155
c⁴ 2048	11.6151	11.6156
c⁵ 4096	11.6152	

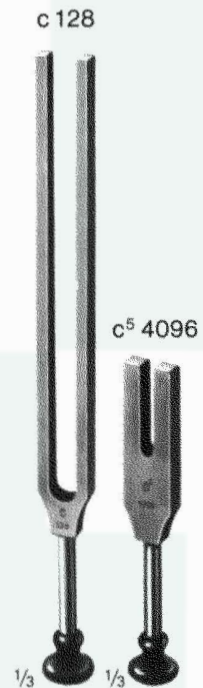

LUCAE

c 128	11.6157
c¹ 256	11.6158
c² 512	11.6159
c³ 1024	11.6160
c⁴ 2048	11.6161
c⁵ 4096	11.6162



a¹ 440  
11.6163

C 64/c 128  
RYDEL-SEIFFER  
11.6164

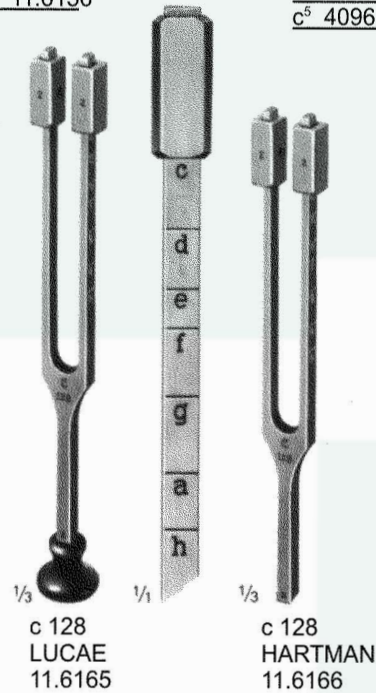

c 128  
LUCAE  
11.6165

c 128  
HARTMAN  
11.6166

verschiebbar bis h  
variable up to h (engl. B)  
variable jusqu' à h (en franc. si)  
variable hasta h (en esp. si)  
regolabile fino alla h (in ital. si)

Stimmgabeln  
 Tuning Forks  
 Diapasons  
 Diapasones  
 Diapason

11.6170  
 Satz zu 5 Stimmgabeln  
 set of 5 tuning forks  
 jeu de 5 diapasons  
 juego de 5 diapasones  
 set di 5 diapason

c 128  
 c<sup>1</sup> 256  
 c<sup>2</sup> 512  
 c<sup>3</sup> 1024  
 c<sup>4</sup> 2048

11.6171  
 Aus aluminium  
 of Aluminium  
 en aluminium  
 de aluminio  
 di alluminio



HARTMANN

11.6172  
 Satz zu 8 Stimmgabeln  
 set of 8 tuning forks  
 jeu de 8 diapasons  
 juego de 8 diapasones  
 set di 8 diapason

c<sub>1</sub> 32  
 c 64  
 c 128  
 c<sup>1</sup> 256  
 c<sup>2</sup> 512  
 c<sup>3</sup> 1024  
 c<sup>4</sup> 2048  
 c<sup>5</sup> 4096

1

2

3

4

5

6

7

8

9

10

11

12

13

14

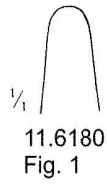

Nasenspekula  
 Nasal Specula  
 Spéculums nasaux  
 Espéculos nasales  
 Specoli nasali

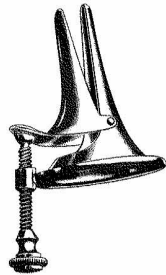

VOLTOLINI  
 11.6180-11.6182

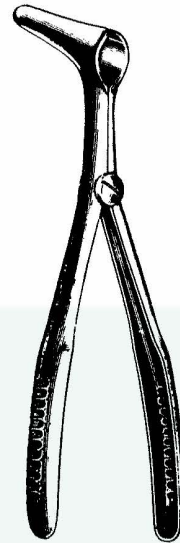

Mod. Wien. Vienna  
 Vienne. Viena  
 11.6190  
 leichtes Modell  
 light weight  
 mod. léger  
 mod. ligero  
 mod. leggero

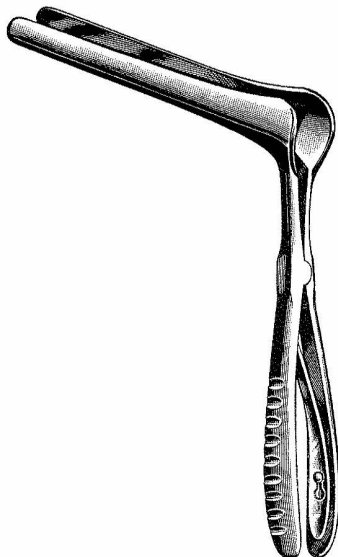

KILLIAN  
 11.6200-11.6203  
 13 cm

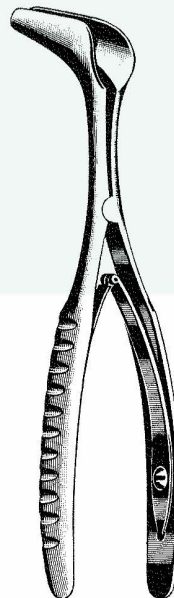
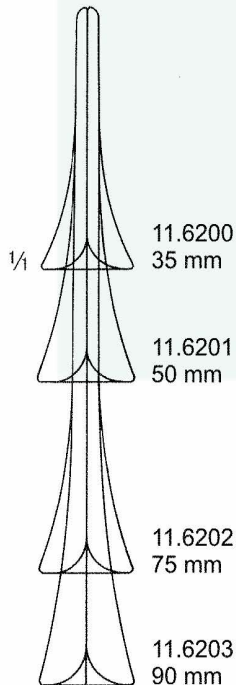

HARTMANN-HALLE  
 11.6210-11.6212  
 15 cm

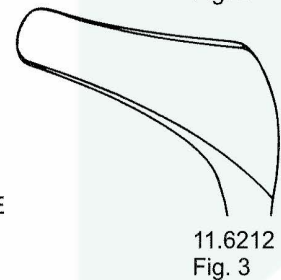
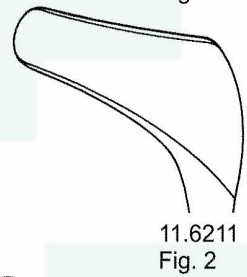
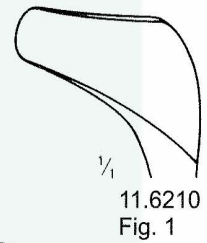



**TROELTSCH**  
 11.6220  
 15 cm

**TROELTSCH**  
 11.6221  
 18 cm



**JANSEN**  
 11.6222  
 20 cm

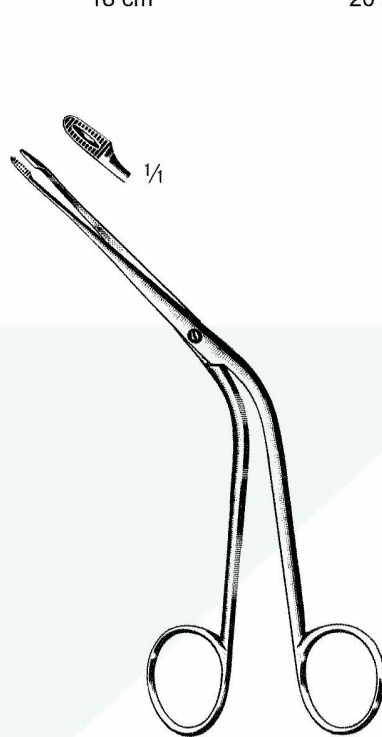

**HARTMANN**  
 11.6230  
 16 cm

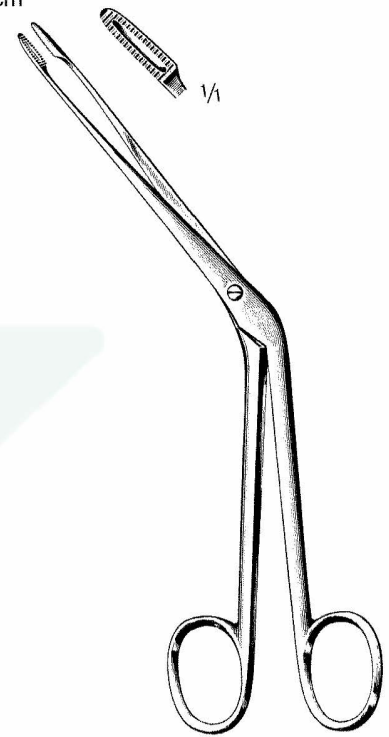

**HARTMANN**  
 11.6231  
 20 cm

Zungenspatel  
 Tongue Depressors  
 Abaisse-langue  
 Abajalengua  
 Abbassalingua



14 cm 08.821  
19 cm 08.822



BRUENINGS  
11.6240  
19 cm

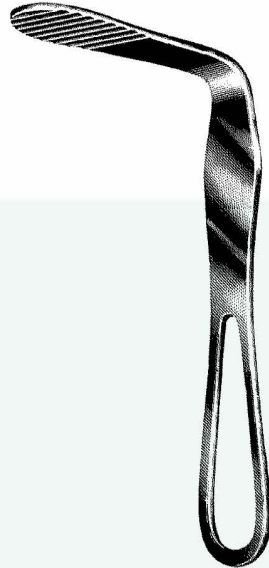

HARTMANN  
11.6241  
15 cm

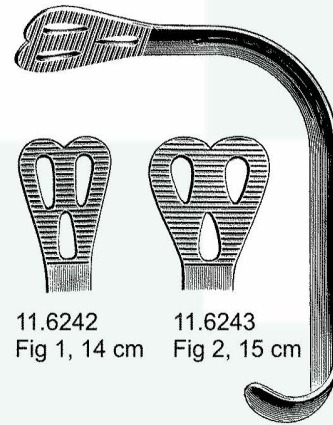

11.6242 Fig 1, 14 cm  
11.6243 Fig 2, 15 cm

WIEDER  
11.6242-11.6243

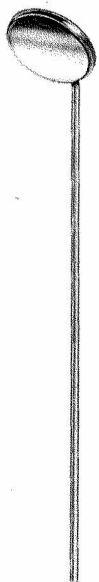

11.6250-11.6261

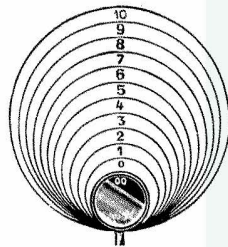

Fig. mm Ø

	Fig.	mm Ø
11.6250	00	8
11.6251	0	10
11.6252	1	12
11.6253	2	14
11.6254	3	16
11.6255	4	18
11.6256	5	20
11.6257	6	22
11.6258	7	24
11.6259	8	26
11.6260	9	28
11.6261	10	30

Kehlkopfspiegel - Laryngeal Mirrors  
 Miroirs Laryngiens - Espejos Laringeos  
 Specchi Laringei



11.6265



11.6270

Mund und Zunge  
 Mouth and Tongue  
 Bouche et langue  
 Boca y lengua  
 Bocca e lingua

Zungenzangen . Tongue Holding Forceps  
 Pincas tire-langue . Pinzas tiralengua  
 Pinze tirilingua

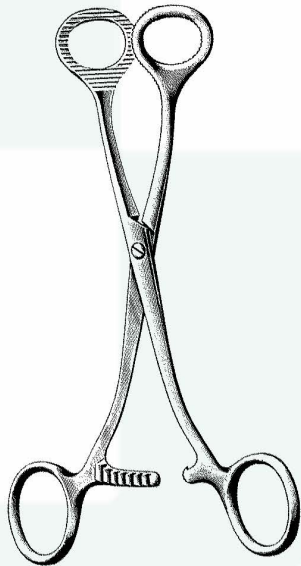

cm	COLLIN
16	11.6280
18	11.6281

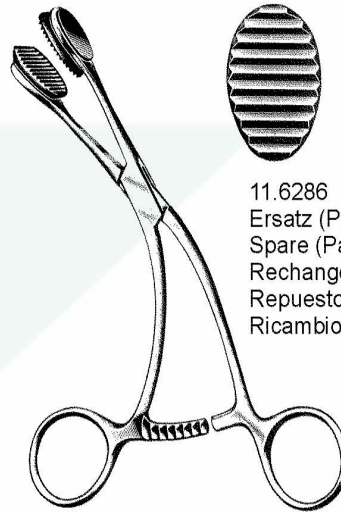

11.6286  
 Ersatz (Paar)  
 Spare (Pair)  
 Rechange (Paire)  
 Repuesto (Pareja)  
 Ricambio (Coppia)

YOUNG  
 11.6285  
 16 cm

Mundsperrer . Mouth Gags  
 Ouvre-bouche . Abrebocas  
 Apribocca

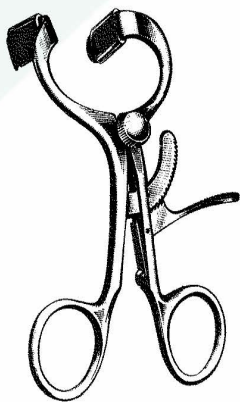

DOYEN-JANSEN (MOLT)  
 11.6290  
 12 cm

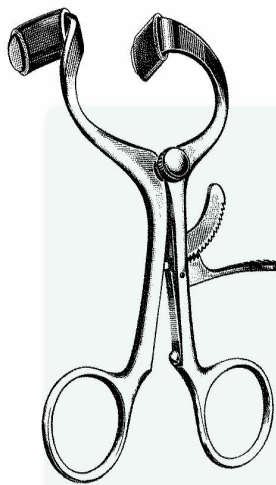

DOYEN-JANSEN (MOLT)  
 11.6291  
 14 cm



MAUNDER  
 11.6292

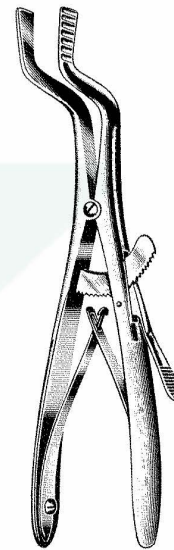

cm	ROSER-KOENIG
16	11.6293
19	11.6294

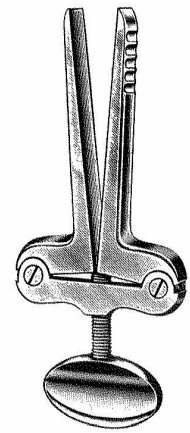

HEISTER  
 11.6295  
 13 cm

Tracheotomie  
 Tracheostomy  
 Trachéotomie  
 Traqueotomia  
 Tracheotomia

Thora  
 Thora  
 Thora  
 Tórax  
 Torax

Tracheotomie  
 Tracheostomy  
 Trachéotomie  
 Traqueotomia  
 Tracheotomia

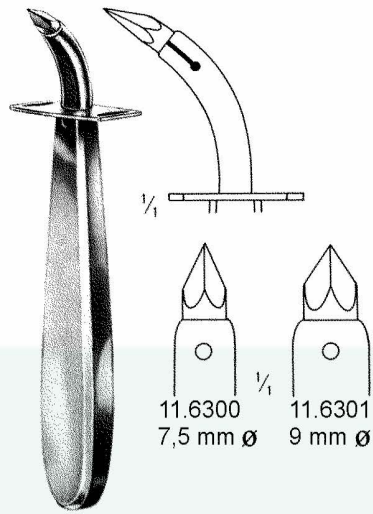

UCKERMANN  
 11.6300 - 11.6301  
 13 cm

Rippenscheren  
 Rib Shears  
 Costotomes  
 Costótomos  
 Costotomi

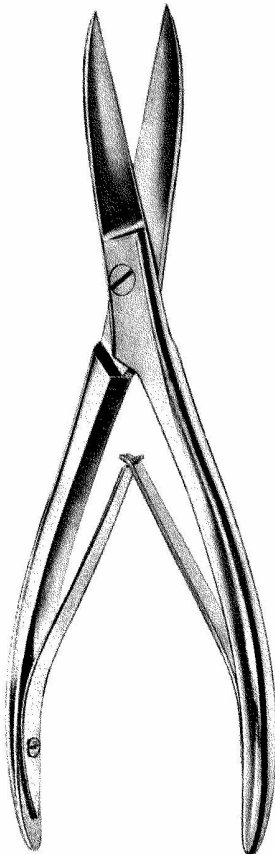

11.6310  
 23 cm

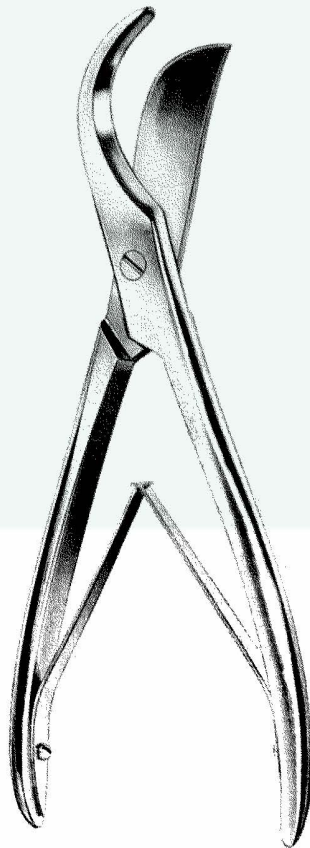

11.6311  
 22 cm

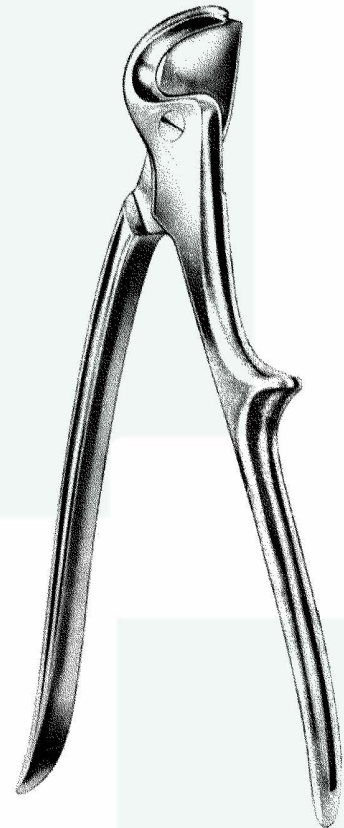

STILLE  
 11.6312  
 21 cm

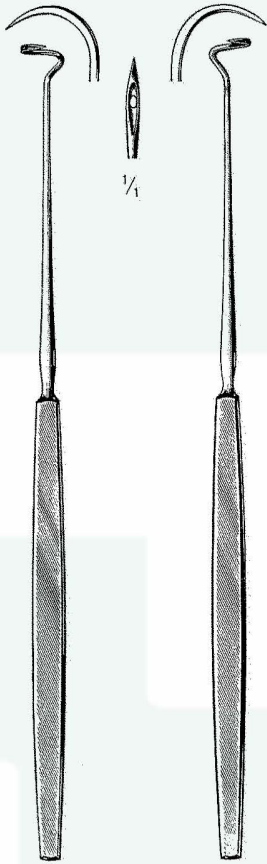

DUPUY-WEISS  
 11.6320 22 cm 11.6321

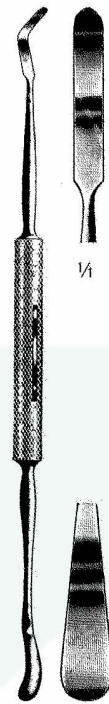

CARPENTER  
 11.6322  
 25 cm

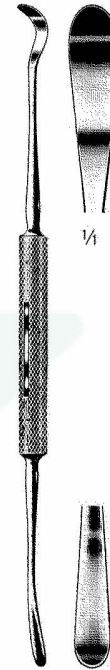

CARPENTER  
 11.6323  
 24 cm

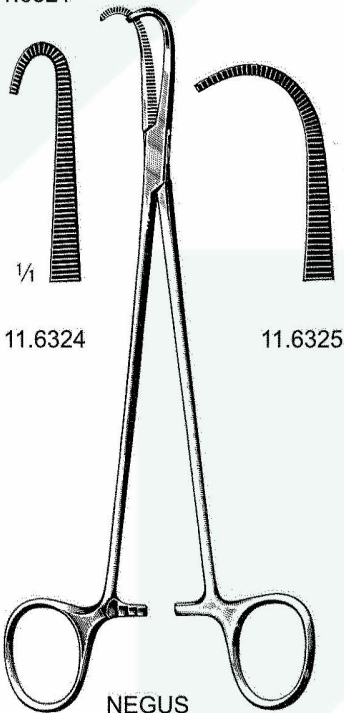

11.6324

11.6325

NEGUS  
 11.6324-11.6325  
 19 cm

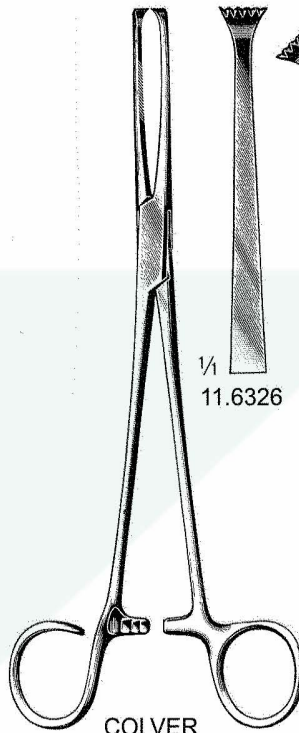

1/1  
 11.6326

11.6327

COLVER  
 11.6326-11.6327  
 19 cm

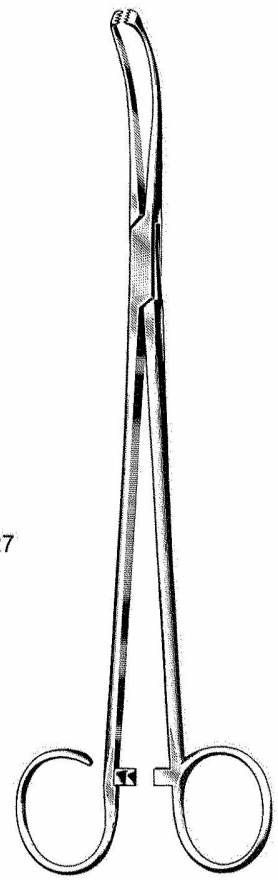

cm	WHITE
18	11.6328
23	11.6329

Tonsillen, Kehlkopf  
Tonsils, Larynx  
Amygdales, Larynx  
Amígdalas, Laringe  
Tonsille, Laringe



**SLUDER-BALLENGER**  
11.6330  
mit 3 Aufsätzen  
with 3 blades  
avec 3 lames  
con 3 hojas  
con 3 lame

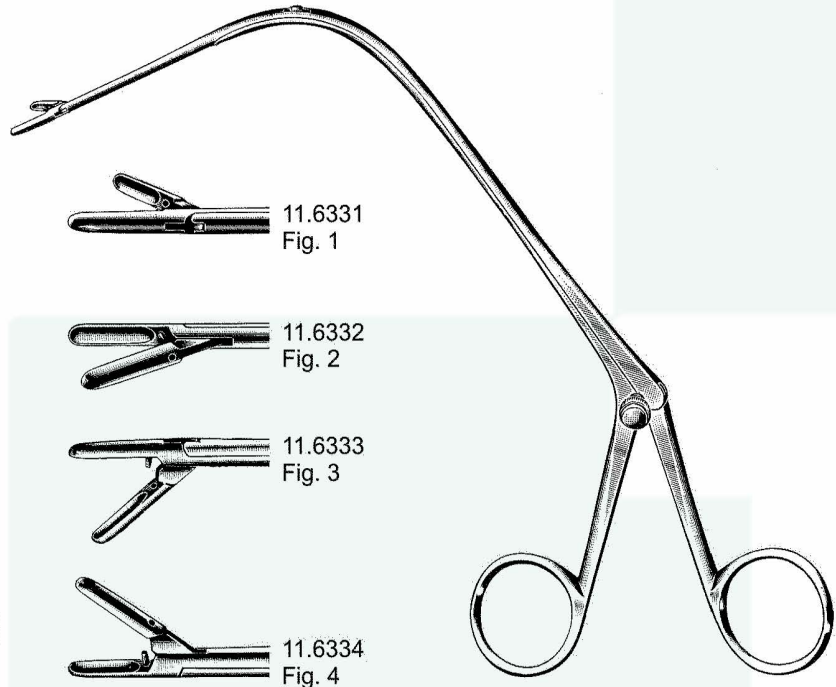

**JURASZ**  
11.6331-11.6334  
23 cm

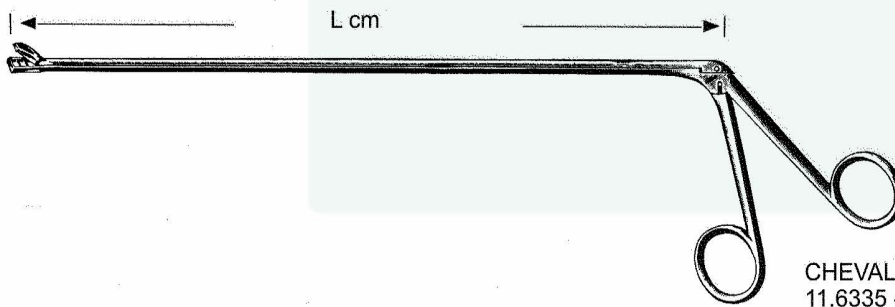

**CHEVALIER-JACKSON**  
11.6335 - 11.6362

cm	Fig. 1	Fig. 2	Fig. 3	Fig. 4	Fig. 5	Fig. 6	Fig. 7
30	11.6335	11.6339	11.6343	11.6347	11.6351	11.6355	11.6359
40	11.6336	11.6340	11.6344	11.6348	11.6352	11.6356	11.6360
50	11.6337	11.6341	11.6345	11.6349	11.6353	11.6357	11.6361
60	11.6338	11.6342	11.6346	11.6350	11.6354	11.6358	11.6362

Galle  
 Gall Bladder  
 Voies biliaires  
 Vesicula biliar  
 Vescicola biliare

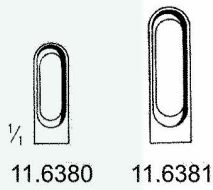
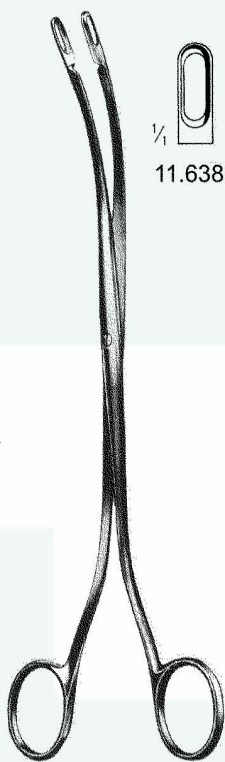

**DESJARDINS**  
 11.6380-11.6381  
 23 cm

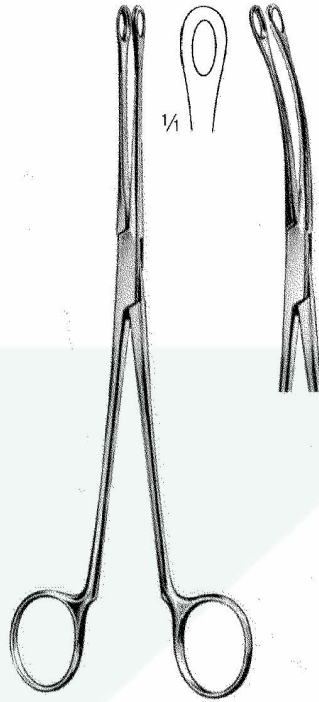

**BLAKE**  
 11.6382 20 cm 11.6383

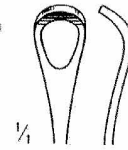
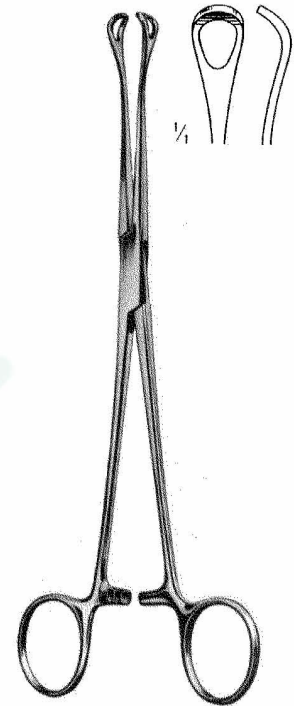

**MAYO BLAKE**  
 11.6384  
 20 cm

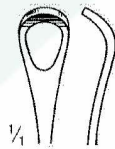
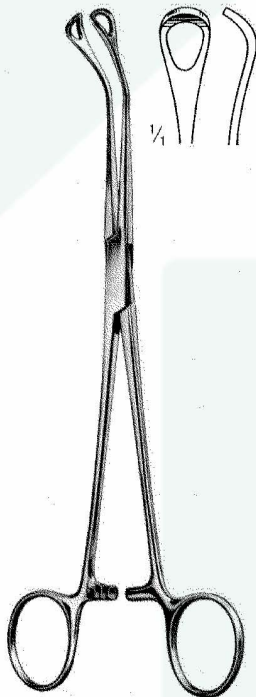

**MAYO BLAKE**  
 11.6385  
 20 cm

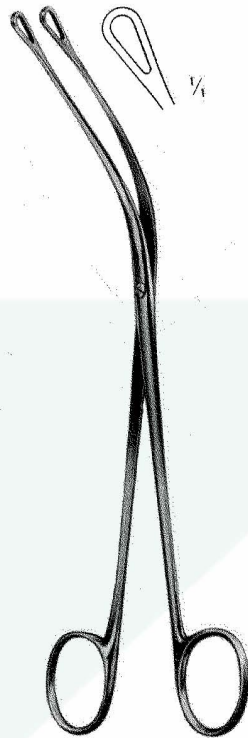

**MIXTER**  
 11.6386  
 22 cm



**MOORE**  
 11.6387



**OCHSNER**  
 11.6388

1

2

3

4

5

6

7

8

9

10

11

12

13

14



MAYO  
 11.6390  
 32 cm

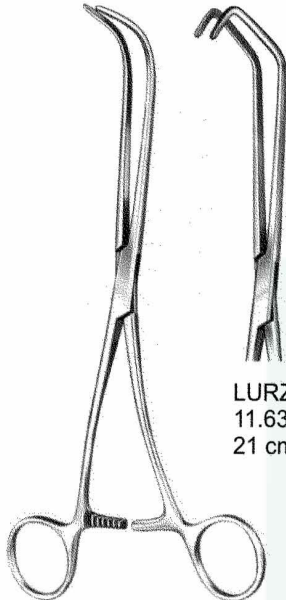

LURZ  
 11.6392  
 21 cm

Ureterklemmen  
 Ureter Clamps  
 Pincés-clamps à urètere  
 Pinzas clamps para ureter  
 Pinze per uretere

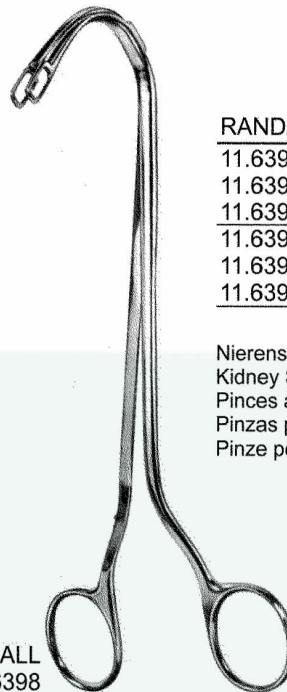

RANDALL  
 11.6393 - 11.6398

RANDALL	Fig.	cm
11.6393	1	23
11.6394	2	22
11.6395	3	22
11.6396	4	22
11.6397	5	19
11.6398	6	19

Nierensteinzangen  
 Kidney Stone Forceps  
 Pincés à calculs renaux  
 Pinzas para cálculos renales  
 Pinze per calcoli renali

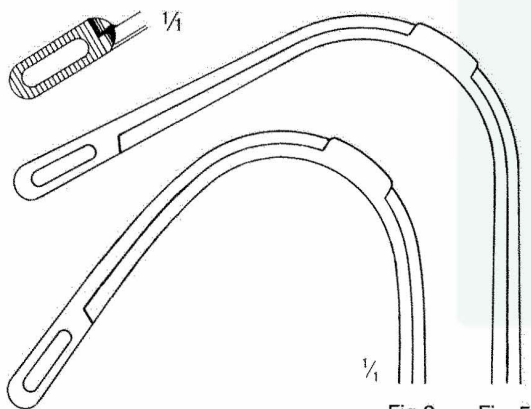

Fig. 6 Fig. 5

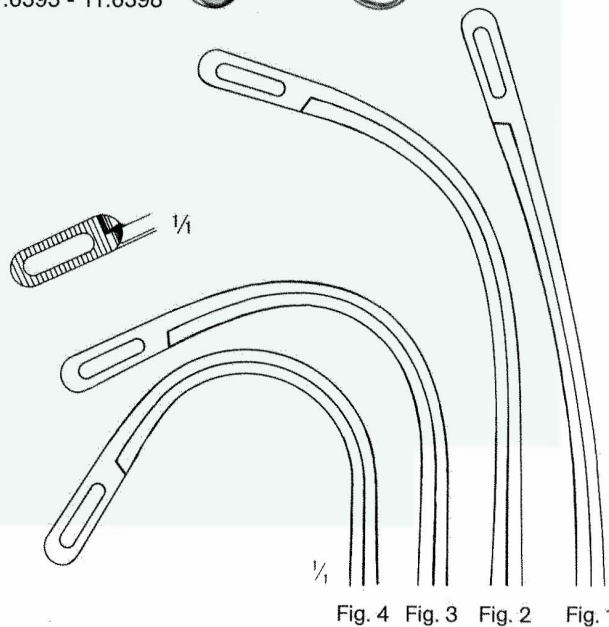
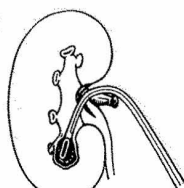
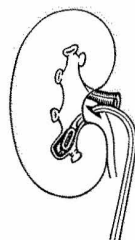

Fig. 4 Fig. 3 Fig. 2 Fig. 1

in situ:



5-6



4

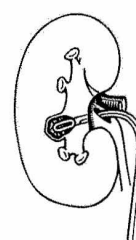

3

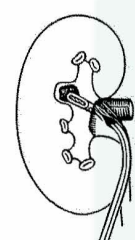

2

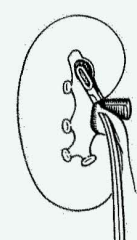

1

Darm, Magen  
 Intestine and Stomach  
 Intestin, Estomac  
 Intestino, Estomago  
 Intestino, Stomaco

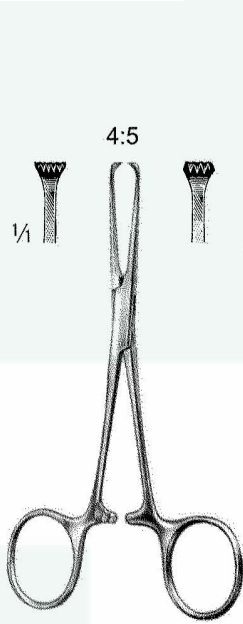

ALLIS-Baby  
 11.6400  
 14 cm

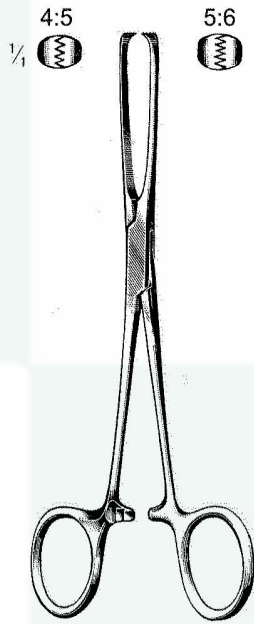

4:5	ALLIS 5:6
11.6401	15 cm 11.6402
	19 cm 11.6403
	22 cm 11.6404
	24 cm 11.6405

Darm-und Gewebefäßzangen  
 Bowel and Tissue Grasping Forceps  
 Pincès à saisir les intestins et les tissus  
 Pinzas para coger intestinos y tejidos  
 Pinze per afferrare intestini e tessuti

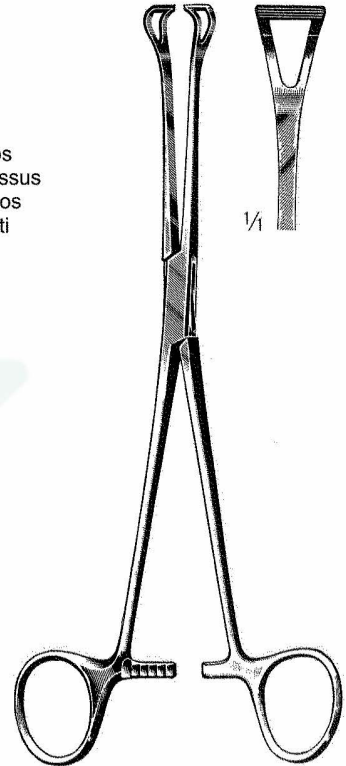

cm	BABCOCK
16	11.6406
18	11.6407
20	11.6408
24	11.6409

Darmklemmen  
 Intestinal Forceps  
 Pincès intestinales  
 Pinzas intestinales  
 Pinze intestinali



DOYEN  
 DOYEN-Baby  
 11.6410-11.6415

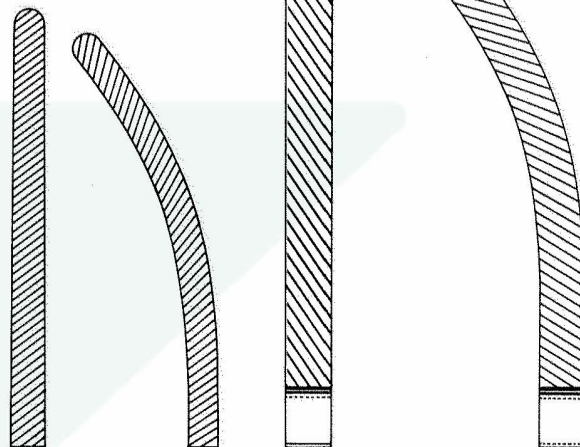

cm	DOYEN-Baby	DOYEN
18	11.6410 11.6411	
21		11.6412 11.6414
23		11.6413 11.6415

Darm, Magen  
 Intestine and Stomach  
 Intestin, Estomac  
 Intestino, Estómago  
 Intestino, Stomaco

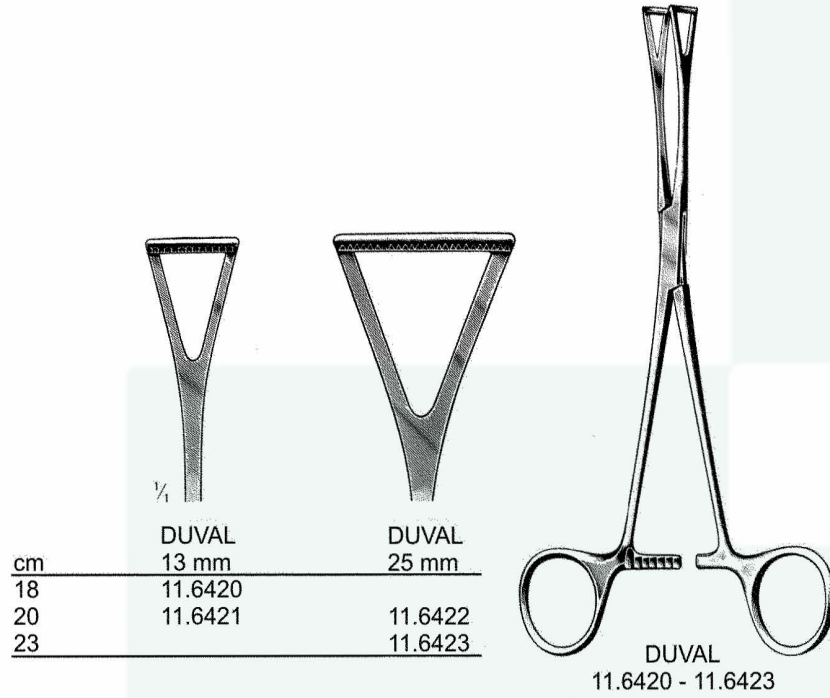

Darmklemmen  
 Intestinal Forceps  
 Pinces intestinales  
 Pinzas intestinales  
 Pinze intestinali

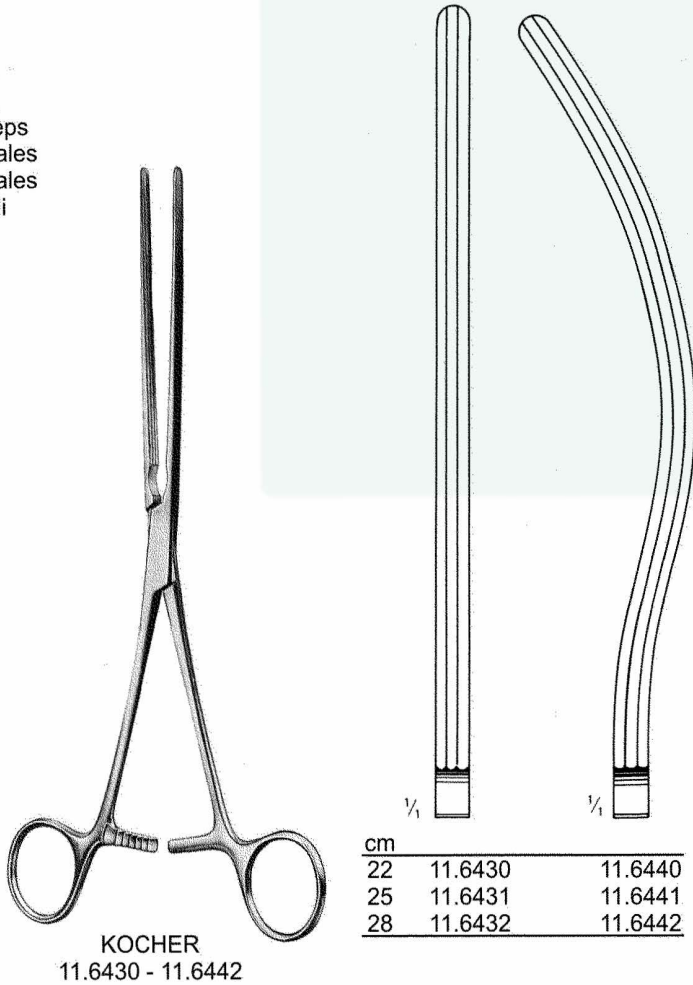

Darm, Magen  
 Intestines and Stomach  
 Intestin, Estomac  
 Intestino, Estomago  
 Intestino, Stomaco

Magenklammern  
 Stomach Clamps  
 Pincas-clamps stomacales  
 Pinzas-clamps estomacales  
 Pinze stomacali

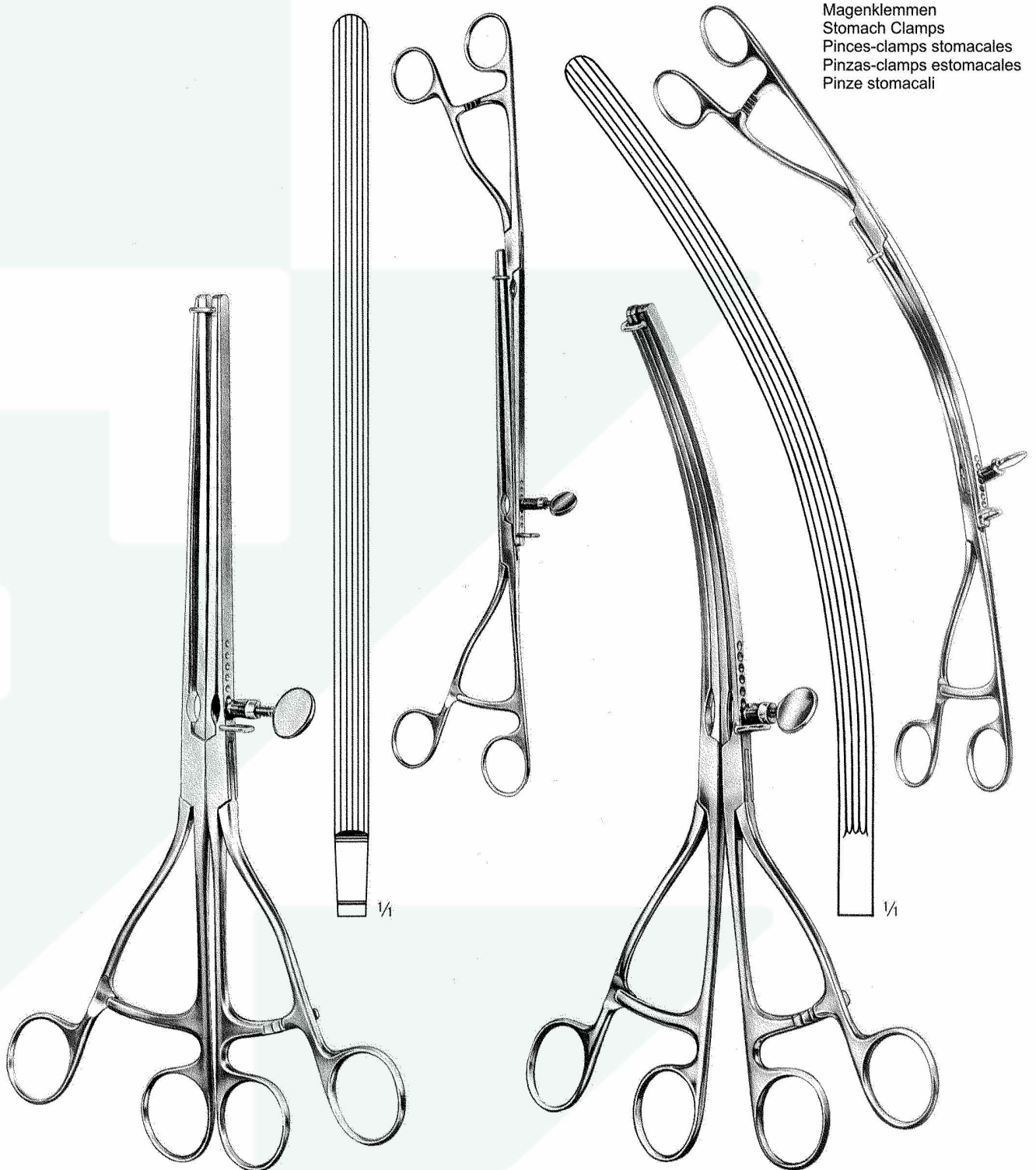

LANE  
 11.6450  
 30 cm

LANE  
 11.6451  
 30 cm

Dilatations-Bougies, Metal-Katheter  
 Dilating Bougies, Metal Catheters  
 Bougies dilatatrices, Sondes métalliques  
 Bujias dilatadoras, Sondas metálicas  
 Candelette dilatatrici, Sonde metalliche



Charr./F.G	van BUREN	GUYON*			COXETER
8	11.6460	11.6478	11.6490	11.6499	11.6508
10	11.6461	11.6479	11.6491	11.6500	11.6509
12	11.6462	11.6480	11.6492	11.6501	11.6510
14	11.6463	11.6481	11.6493	11.6502	11.6511
16	11.6464	11.6482	11.6494	11.6503	11.6512
18	11.6465	11.6483	11.6495	11.6504	11.6513
20	11.6466	11.6484	11.6496	11.6505	11.6514
22	11.6467	11.6485	11.6497	11.6506	11.6515
24	11.6468	11.6486	11.6498	11.6507	11.6516
26	11.6469				
28	11.6470				
30	11.6471				
32	11.6472				
34	11.6473				
36	11.6474				
38	11.6475				
40	11.6476				
	11.6477				
	Set compl				
	8-36				

	Ch./F.G.	No.
*Zwischengrößen:	9	11.6487
Intermediate Sizes:	11	11.6488
Dimensiones Intermediarias:	.	.
Dimensiones Intermediarias:	.	.
Dimensioni intermedie:	39	11.6489

Mastdarm  
 Rectum  
 Rectum  
 Recto  
 Retto

Mastdarm-Spekula  
 Rectal Specula  
 Spéculum rectaux  
 Espéculos rectales  
 Specoli rettali

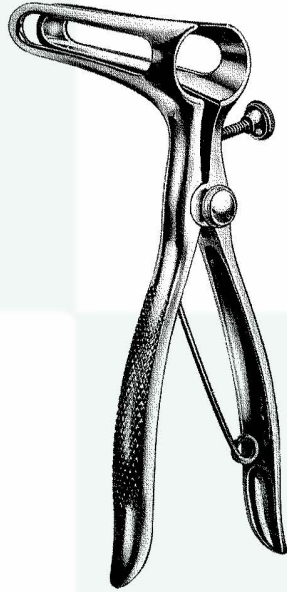

SIMS  
 11.6520  
 15 cm

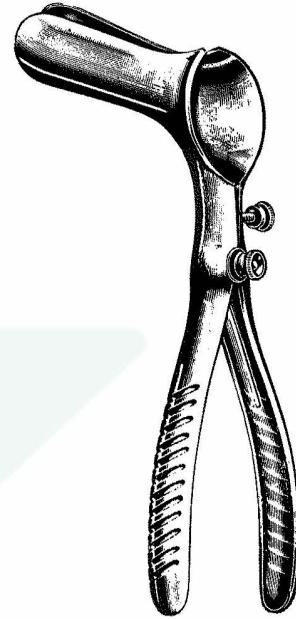

PRATT  
 11.6521

Anoskope, Proktoskope  
 Anoscopes, Proctoscopes  
 Anuscopes, Proctoscopes  
 Anoscopios, Proctoscopios  
 Anoscopi, Protoscopi



mm Ø x L	KELLY
22x 50	11.6522
22x 100	11.6523
22x 140	11.6524
22x 200	11.6525

Cystikus-Haken  
 Cystic Hooks  
 Ecarteurs rectaux  
 Ganchos rectales  
 Uncini rettali

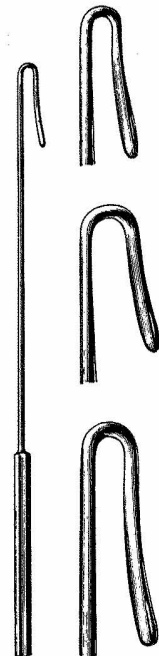

11.6526  
 Fig. 1

11.6527  
 Fig. 2

11.6528  
 Fig. 3

PRATT  
 11.6526 - 11.6528

Sterilisationsinstrumente  
 Sterilization Instruments  
 Instruments à stérilisation  
 Instrumentos para la esterilización  
 Strumenti per la sterilizzazione

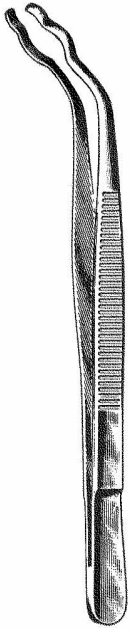

cm	DAVIS
16	11.7000
20	11.7001
24	11.7002

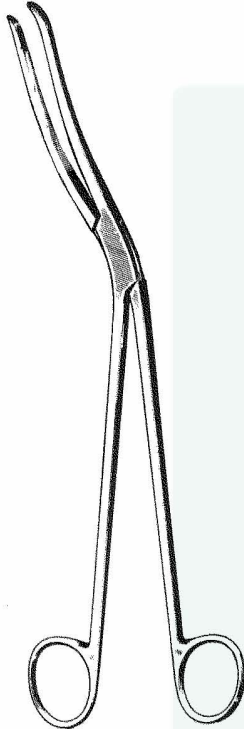

CHEATLE  
 11.7003  
 27 cm

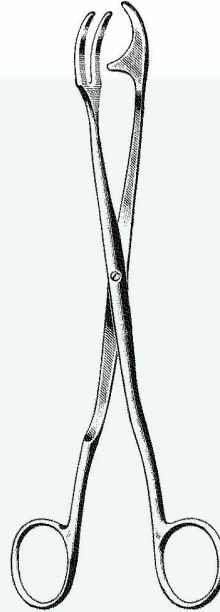

ROGGE  
 11.7004  
 23 cm

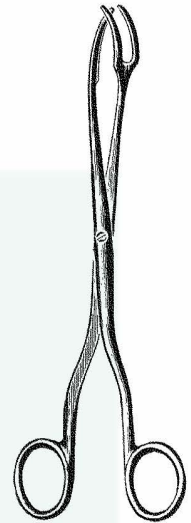

cm	
20	11.7005
30	11.7006

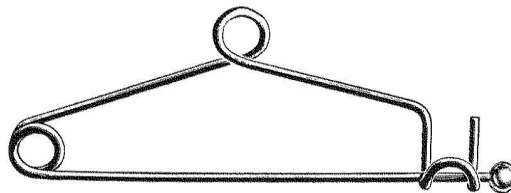

MAYO  
 11.7007  
 14 cm



Watteträger  
 Cotton applicators  
 Porte-coton  
 Porta-algodón  
 Porta cotone

cm	
12,0	11.7010
14,0	11.7011
16,0	11.7012
18,0	11.7013

30 cm 11.7013.10

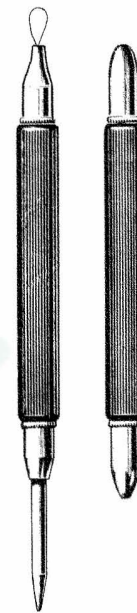

11.7014

Augen-Magnet  
 Eye Magnet  
 Aimant à corps étrangers  
 Imán para cuerpos extranjeros  
 Calamita per corpi estranei

Wundklammerzaengchen  
 Suture forceps  
 Pincers pour agraffes  
 Pinza para agraffes  
 Pinze per punti



MICHEL  
 11.7015  
 12 cm



MICHEL  
 11.7016  
 12 cm

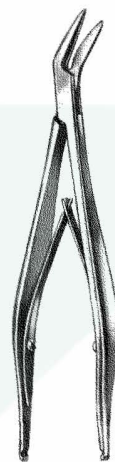

MICHEL  
 11.7017  
 13 cm

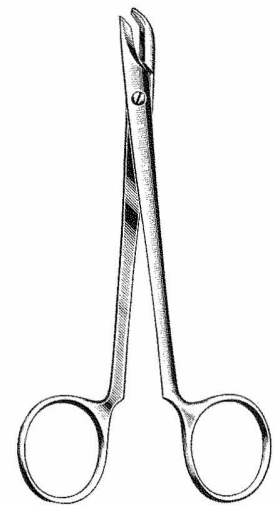

COLLIN  
 11.7018  
 13 cm

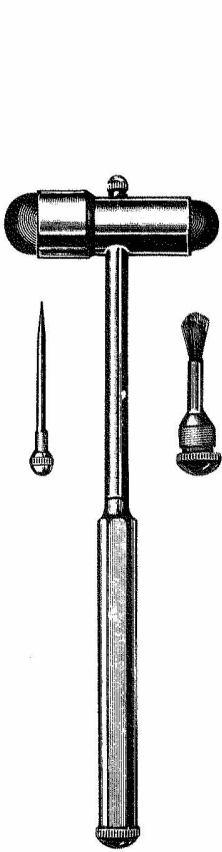

BUCK  
 08.910  
 18 cm

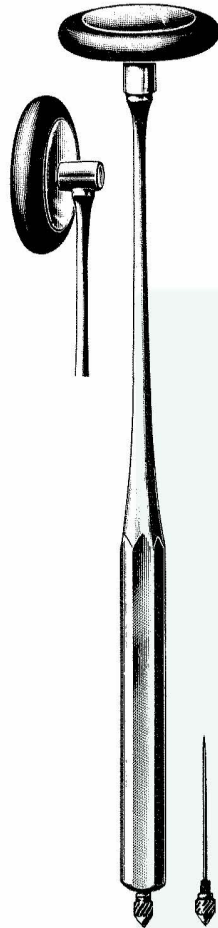

BABINSKY  
 08.911  
 22 cm

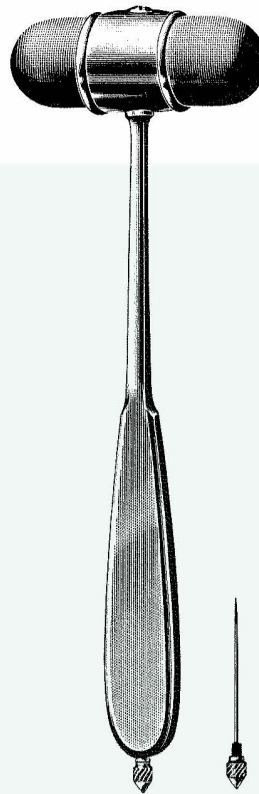

DEJERINE  
 08.912  
 20 cm

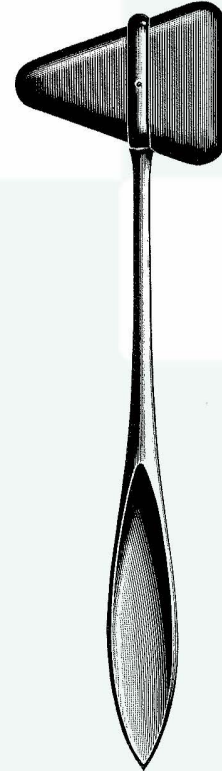

cm TAYLOR  
 19 08.913 Plastic Handle  
 20 08.914 Chrome Plated Handle

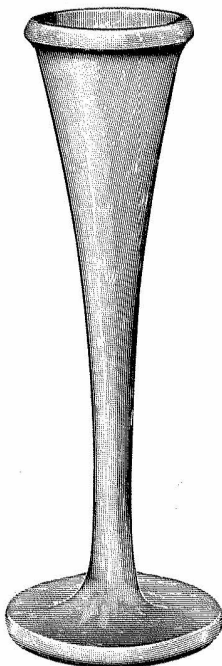

PINARD  
 08.899 Wood  
 08.900 Aluminium



POOLE  
 11.7020  
 10 mm Ø (30Fr.)

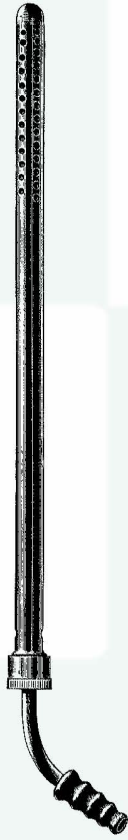

POOLE  
 11.7021  
 8 mm Ø (23Fr.)

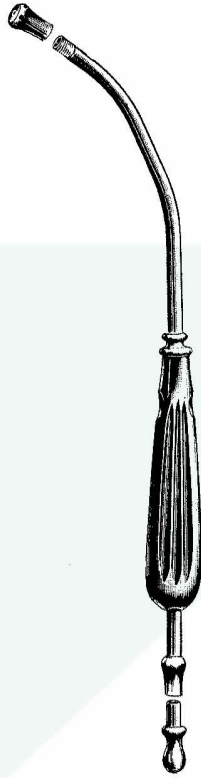

YANKAUER  
 11.7030  
 27 cm

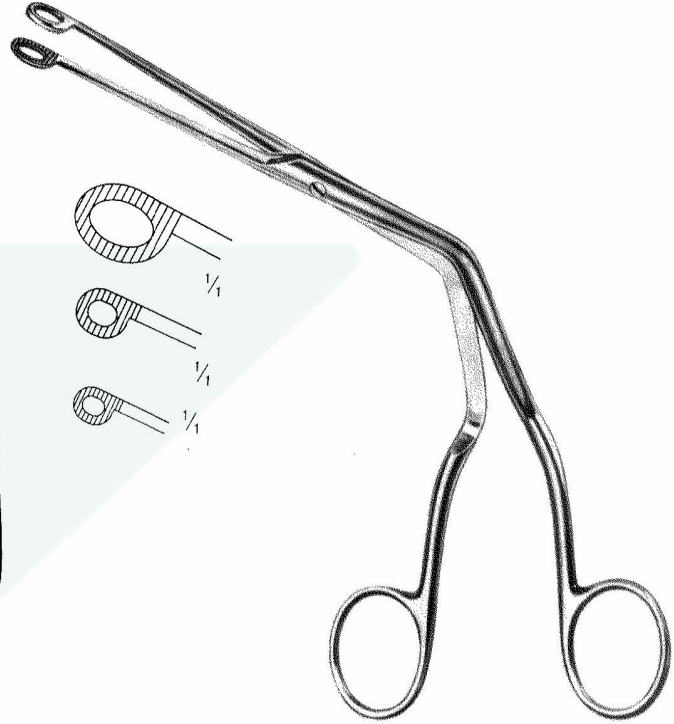

cm	MAGILL
17	08.800
20	08.801
25	08.802

Charr.	F.G.	30°
6	11.7041	
7	11.7042	
8	11.7043	
9	11.7044	
10	11.7045	
11	11.7046	
12	11.7047	

Charr.	F.G.	75°
6	11.7048	
7	11.7049	
8	11.7050	
9	11.7051	
10	11.7052	
11	11.7053	
12	11.7054	

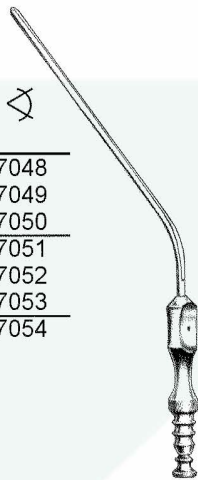

FRAZIER  
 11.7041-11.7054  
 19 cm



ADSON  
 11.7040  
 21 cm / 4 mm

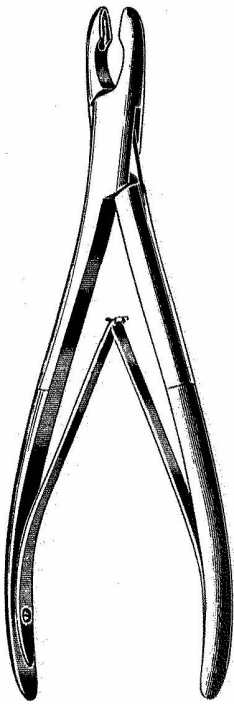

ADSON  
 11.8000 20 cm 11.8001

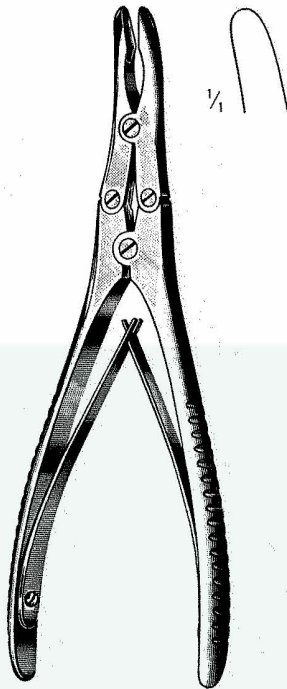

RUSKIN  
 11.8002 18 cm 11.8003

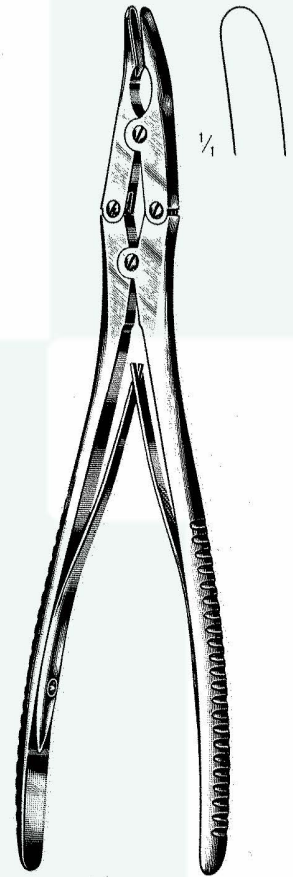

RUSKIN  
 11.8004  
 23 cm

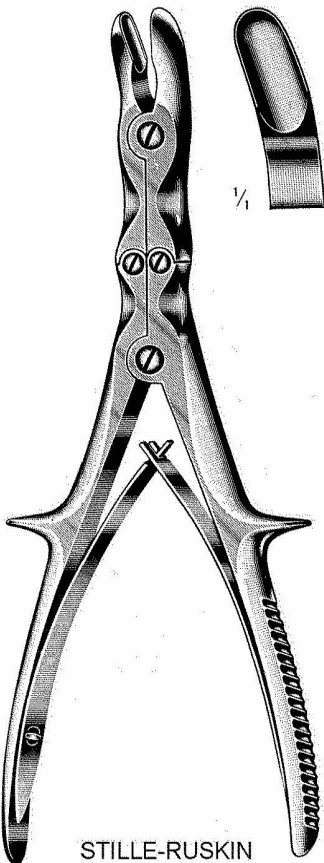

STILLE-RUSKIN  
 11.8005  
 23 cm

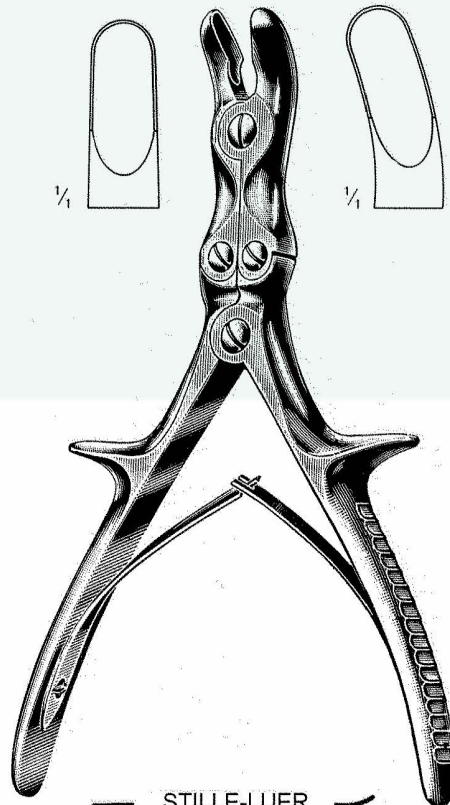

STILLE-LUER  
 11.8006 22 cm 11.8008  
 11.8007 26 cm 11.8009

Knochenchirurgie  
 Bone Surgery  
 Chirurgie osseuse  
 Cirugía ósea  
 Chirurgia ossea

Knochensplitterzangen  
 Bone Cutting Forceps  
 Pinces coupantes à os  
 Pinzas cortantes para huesos  
 Cesioie per ossa

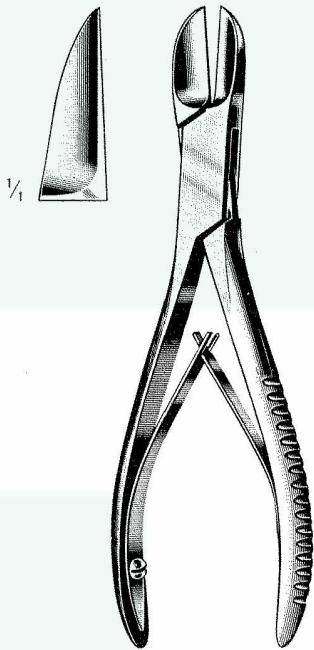

**LISTON**  
 11.8010 14 cm 11.8014  
 11.8011 17 cm 11.8015  
 11.8012 19 cm 11.8016  
 11.8013 22 cm 11.8017

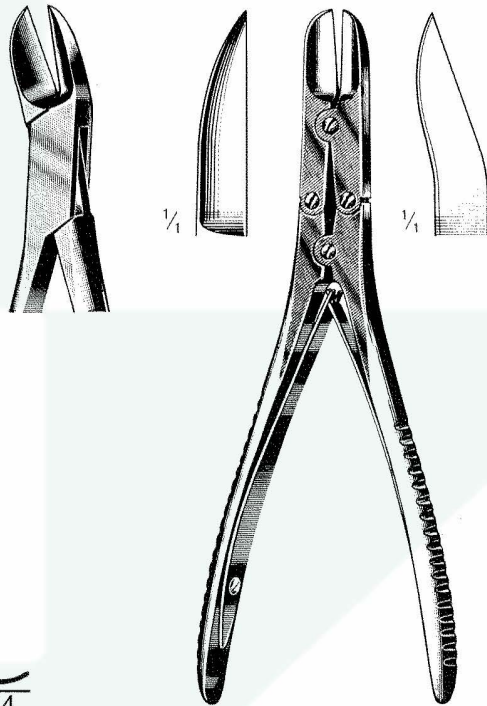

**RUSKIN-LISTON**  
 11.8018 18,5 cm 11.8019

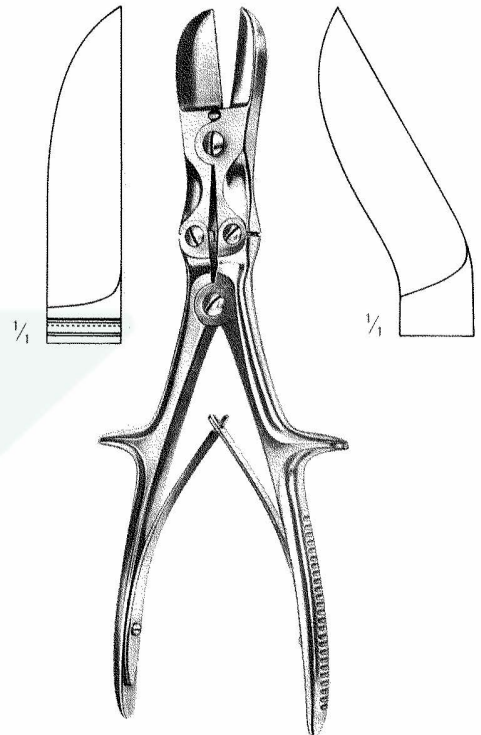

**STILLE-LISTON**  
 11.8020 27 cm 11.8021

Knochenhalte-zangen  
 Bone Holding Forceps  
 Daviers porte-os  
 Pinzas para huesos  
 Tenaglie per ossa

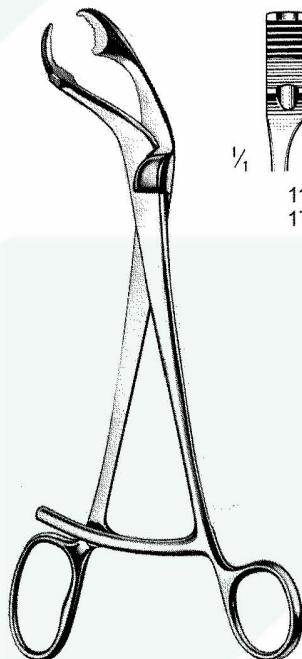

**VERBRUGGE**  
 11.8022-11.8025

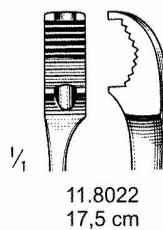

11.8022  
 17,5 cm

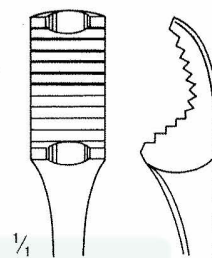

11.8023  
 25 cm

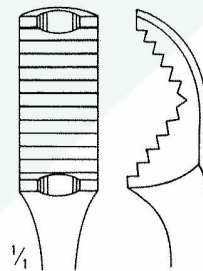

11.8024  
 26 cm

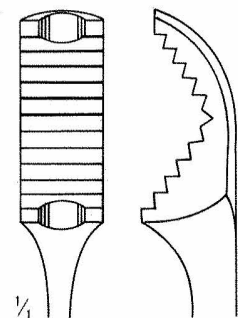

11.8025  
 27 cm

Knochenhalte­zangen  
 Bone Holding Forceps  
 Daviers porte-os  
 Pinzas para huesos  
 Tenaglie per ossa

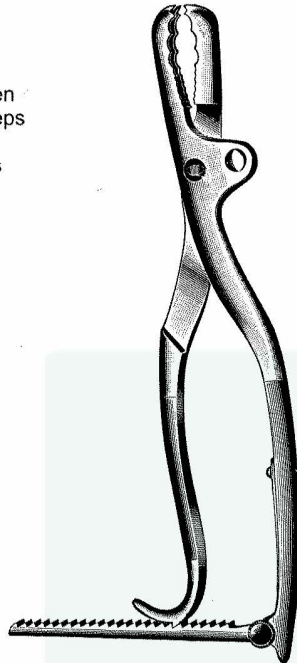

**FARABEU­F-LAMBOTTE**  
 11.8050  
 26 cm

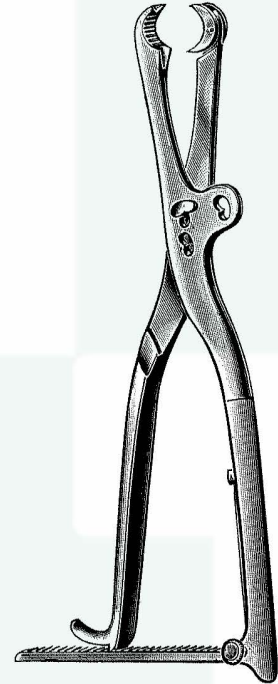

cm	LAMBOTTE
22	11.8051
27	11.8052
30	11.8053



Fig.	SIMON
1	11.8030
2	11.8031
3	11.8032
4	11.8034
5	11.8035
6	11.8036

24 cm

Fig.  
 0 1  
 0 2  
 0 3  
 0 4  
 0 5  
 0 6  
 $\frac{1}{2}$

Scharfe Löffel  
 Bone Curettes  
 Curettes à os  
 Cucharillas cortantes  
 Curette taglienti

Fig.	VOLKMANN
0000	11.8040
000	11.8041
00	11.8042
0	11.8043
1	11.8044
2	11.8045
3	11.8046
4	11.8047
5	11.8048
6	11.8049

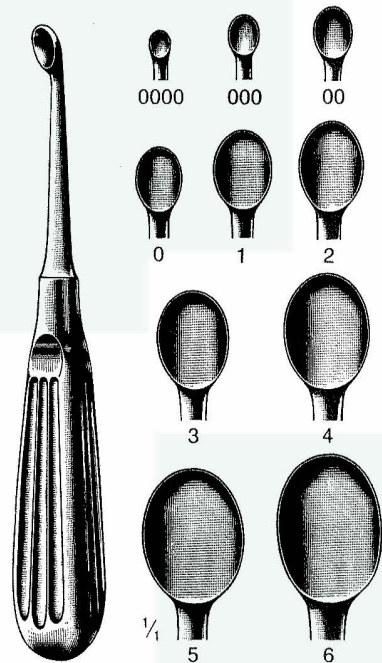

**VOLKMANN**  
 11.8040-11.8049  
 17 cm



mm	HIBBS				
6	11.8060	11.8065	11.8070	11.8075	11.8080
13	11.8061	11.8066	11.8071	11.8076	11.8081
19	11.8062	11.8067	11.8072	11.8077	11.8082
25	11.8063	11.8068	11.8073	11.8078	11.8083
32	11.8064	11.8069	11.8074	11.8079	11.8084
	24 cm	24 cm	24 cm	24 cm	24 cm

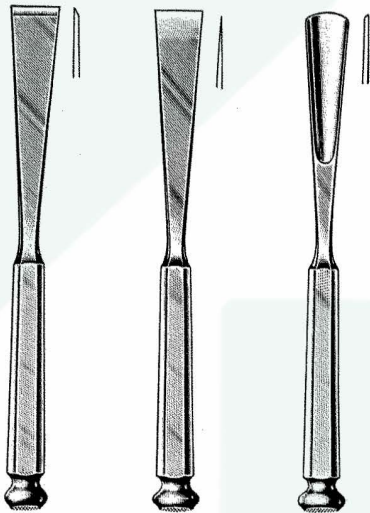

mm	STILLE		
	20 cm	20 cm	20 cm
10	11.8085	11.8089	11.8093
15	11.8086	11.8090	11.8094
20	11.8087	11.8091	11.8095
25	11.8088	11.8092	11.8096

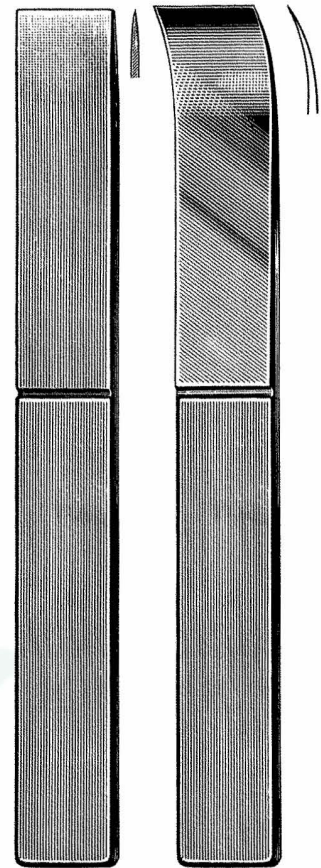

mm	LAMBOTTE	
6,5	11.8097	11.8104
15,0	11.8098	11.8105
20,0	11.8099	11.8106
25,0	11.8100	11.8107
30,0	11.8101	11.8108
38,0	11.8102	11.8109
44,0	11.8103	11.8110
	24 cm	23 cm

mm	
3	11.8121
5	11.8122
7	11.8123

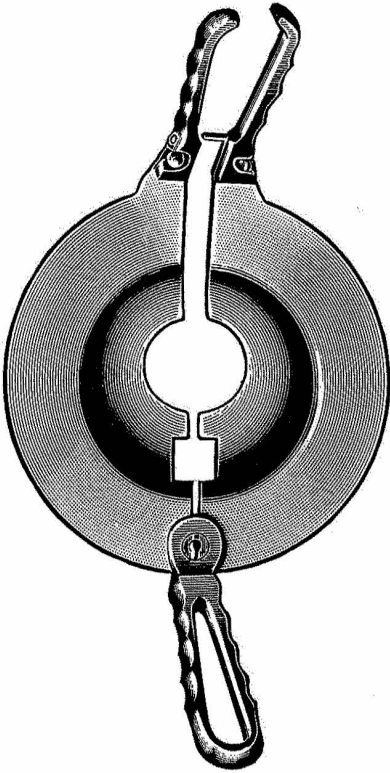

PERCY  
 11.8120

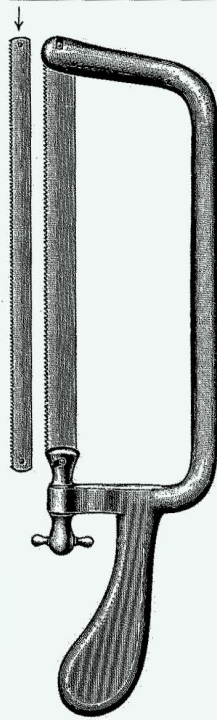

CHARRIERE  
 11.8121-11.8123

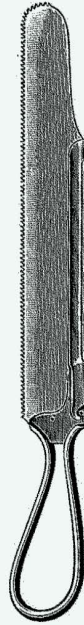

CHARRIERE  
 11.8124  
 30 cm

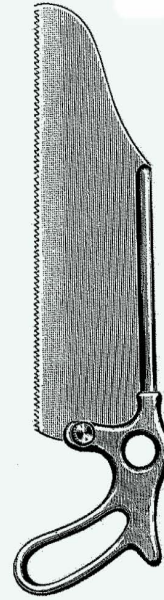

SATTERLEE  
 11.8125  
 31 cm



LANGENBECK  
 11.8126  
 23 cm

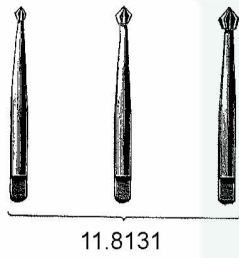

11.8131

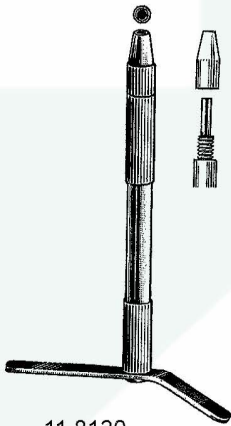

11.8130  
 Compl. incl.  
 11.8131

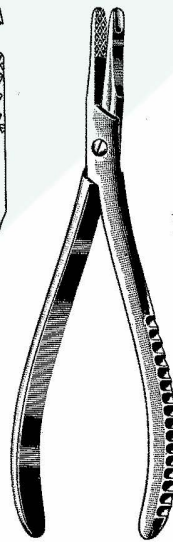
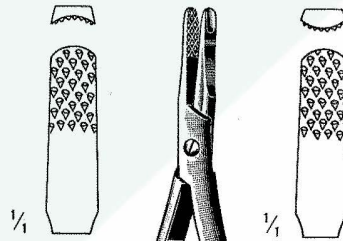

RADOLF  
 11.8132  
 13,5 cm



11.8134 Blade

11.8133 w/o Blade



## ***Kopek International***

The Instrument Company

Back Side of Honda Falcon

Pakki Kotli Daska Road Sialkot Pakistan

Tell : + 92-52-3552324 Fax : +92-52-3555464

URL : [www.kopek-international.com](http://www.kopek-international.com)

E-mail: [mail@kopek-international.com](mailto:mail@kopek-international.com)